

ZENTEN

CATÁLOGO | KATALOG | CATALOG | CATALOGUE



# ZENTEN

SINCE 1966

## We build tools, professional tools

ZENTEN Bernhard Groten S.L. fue fundada en 1966 por Bernhard Groten, natural de Solingen (Alemania). Somos una organización situada en Irun, España. Formada por 30 especialistas en la fabricación de herramientas de mano. Creamos, desarrollamos y fabricamos para quienes aprecian la excelencia en las herramientas y desean conocer el verdadero origen de los productos que manejan. La alta calidad, un diseño innovador y el perfecto acabado de nuestras herramientas, junto con un excelente servicio, hacen que estemos presentes en los mercados más importantes de todo el mundo a través de los fabricantes y distribuidores más prestigiosos, alcanzando una cifra de exportación del 95%.

ZENTEN Bernhard Groten S.L. wurde 1966 von Bernhard Groten aus Solingen gegründet. Mit Firmensitz in Irun (Spanien), ZENTEN besteht aus 30 Experten in der Herstellung von Handwerkzeugen. Wir entwickeln und produzieren für alle, die die Exzellenz bei Werkzeugen zu schätzen wissen und die genaue Herkunft der von ihnen benutzten Werkzeuge kennen wollen. Hohe Qualität, innovatives Design sowie perfektes Finish, verbunden mit einem exzellenten Service, sind die Grundlagen der Präsenz unseres Unternehmens auf den wichtigsten Weltmärkten, vertreten durch die bekanntesten Hersteller und Großverteiler, mit einem Export-Anteil unserer Produktion von 95%.

ZENTEN Bernhard Groten S.L was founded in 1966 by Bernhard Groten, a native of Solingen (Germany). We are a company located in Irun, Spain, which consists of 30 specialists in the hand tool manufacturing. We create, develop and build tools for those who appreciate professional tools and are willing to know the origin of the tools they work with. High quality, innovative design and perfect finishing of the products we manufacture, along with an excellent service, makes possible for us to be present in the most important markets all over the world by means of the most prestigious manufacturers and distributors, reaching an export figure of 95%.

ZENTEN Bernhard Groten S.L fut fondée en 1966 par Bernhard Groten, originaire de Solingen (Allemagne). Elle est une organisation située à Irun, Espagne, qui est formée par 30 spécialistes dans la fabrication d'outils à main. Nous créons, développons et fabriquons pour ceux qui apprécient les outils authentiques, et veulent connaître la véritable origine des outils qu'ils manient. La haute qualité, les dessins innovateurs et le parfait finissage de nos outils, unis à un excellent service, font que ZENTEN soit présent dans les marchés les plus importants du monde par les fabricants et distributeurs les plus prestigieux, atteignant un chiffre record d'exportation stable de 95%.

# Our team



30 specialists in the  
hand tool manufacturing



# Personalización de los productos

## Produkt-Personalisierung

## Product customitation

## Personnalisation des produits

ZENTEN

Nuestros productos presentan la máxima calidad disponible en el mercado en su especialidad.  
Perseguimos la excelencia, la innovación, la flexibilidad de diseño, fabricación y servicio, para poder ofrecer un producto diferenciado, singular, que se distinga de lo existente.

Unsere Werkzeuge entsprechen den höchsten Qualitätsanforderungen.  
Wir versuchen, die Perfektion zu erreichen, um durch Innovation und maximale Flexibilität in Design, Herstellung und Service, Produkte anbieten zu können, die sich von Allem, was schon da ist, unterscheiden.

Our products represent the maximum quality available in this field.  
We pursue excellence, innovation, design, manufacturing and service flexibility, in order to offer a highly differentiated product, setting itself apart from the rest of existing tools.

Nos produits représentent la plus grande qualité disponible sur le marché dans sa spécialité.  
Nous poursuivons l'excellence, l'innovation, la flexibilité du dessin, la fabrication et le service pour pouvoir offrir un produit différencié, unique, qui se distingue du reste des produits existants.



COLOR  
FARBE  
COULEUR  
COULEUR

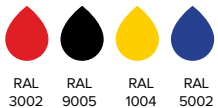

RAL 3002 RAL 9005 RAL 1004 RAL 5002

Colores standar  
Standardfarben  
Standar colours  
Couleurs standard

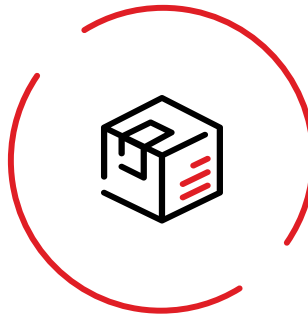

EMPAQUETADO  
VERPACKUNG  
PACKAGING  
EMBALLAGE



Producto a granel  
Lose Ware  
Bulk product  
Produit en vrac



Producto en display  
Produkt auf SB-Karte  
Product in display  
Produit sur carte display

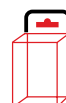

Producto en blister  
Produkt in Blister  
Product in blister  
Produit en blister

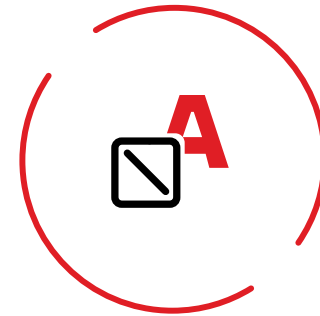

MARCADO  
MARKIERUNG  
BRANDING  
MARQUAGE

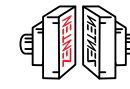

Marcado de fundición  
Gusslogo  
Die-cast branding  
Marquage de fonte



Marcado Láser  
Lasermarkierung  
Laser branding  
Marquage laser

<p>Para mangueras flexibles de plástico.  Für flexible Kunststoffschläuche.  For flexible plastic hoses.  Pour tuyaux flexibles en plastique.</p>	08
<p>Para mangueras flexibles, tubos de plástico de material blando y tubos de plástico de paredes delgadas.  Für flexible Schläuche, weiche Kunststoffrohre und dünnwandige Kunststoffrohre.  For flexible hoses, soft plastic tubes and thin walled plastic tubes.  Pour tuyaux flexibles, tubes en plastique à matériel souple et tubes en plastique à paroi mince.</p>	12
<p>Para tubos multicapa.  Für Verbundrohre.  For multilayer tubes.  Pour tubes multicouche.</p>	16
<p>Para tubos de plástico y multicapa.  Für Kunststoff- und Verbundrohre.  For plastic and multilayer tubes.  Pour tubes en plastique et multicouche.</p>	20
<p>Para tubos metálicos de pared delgada.  Für dünnwandige Metallrohre.  For thin metal tubes.  Pour tubes métalliques à paroi mince.</p>	30
<p>Para tubos de inox.  Für Inox Rohre.  For inox tubes.  Pour tubes en inox.</p>	44
<p>Para tubos de acero e inox.  Für Stahl- und Inox Rohre.  For steel and inox tubes.  Pour tubes en acier et inox.</p>	50
<p>Cuchillas de recambio.  Ersatzrädchen.  Cutting wheels.  Molettes de rechange.</p>	56
<p>Herramientas de fontanería.  Installationswerkzeuge.  Plumbing tools.  Outils pour plomberie.</p>	62
<p>Plomada trazadora.  Schlagschnurroller.  Chalk line.  Cordeau traceur.</p>	66
<p>Cuchillos.  Messer.  Knives.  Couteaux.</p>	72





# 01

---

**Para mangueras flexibles de plástico**  
**Für flexible Kunststoffschläuche**  
**For flexible plastic hoses**  
**Pour tuyaux flexibles en plastique**

---

ZENTEN



## MAGNESIUM

Para mangueras flexibles de plástico.

Für flexible Kunststoffschläuche.

For flexible plastic hoses.

Pour tayaux flexibles en plastique.

REF.	gr.	DISPLAY		
5014-0	80	----		
5014-1	90	•		



Registered Design



### Eficiente / Effizient / Efficient / Efficient

- Mínimo esfuerzo requerido para el corte.
- Minimale Anwendungskraft für den Schnitt.
- Minimal effort required for cutting.
- Minimum d'effort requis pour la coupe.



### Calidad / Qualität / Quality / Qualité

- Cuchilla "Made in Solingen / Germany". Geometría de corte especial y recubrimiento de PTFE.
- Klinge „Made in Solingen / Germany“. Optimale Schneidgeometrie und mit PTFE-Beschichtung.
- "Made in Solingen / Germany" blade. Special edge geometry and PTFE Coating.
- Lame "Made in Solingen / Germany". Géométrie de coupe spéciale et recouvrement de PTFE.



### Práctico / Praktisch / Practical / Pratique

- Retroceso de la cuchilla automático.
- Automatischer Klingentrückzug.
- Automatic blade release.
- Retour automatique de la lame.



### Útil / Handlich / Handy / Utile

- Sistema de cierre con una sola mano.
- Einhandverschlussystem.
- One handed locking system.
- Système de fermeture avec une seule main.

## MAGNESIUM

Para mangueras flexibles de plástico.

Für flexible Kunststoffschläuche.

For flexible plastic hoses.

Pour tayaux flexibles en plastique.

REF.	GT	DISPLAY	Box
5022-0	150	----	
5022-1	160	•	



+ PTFE

5011-1

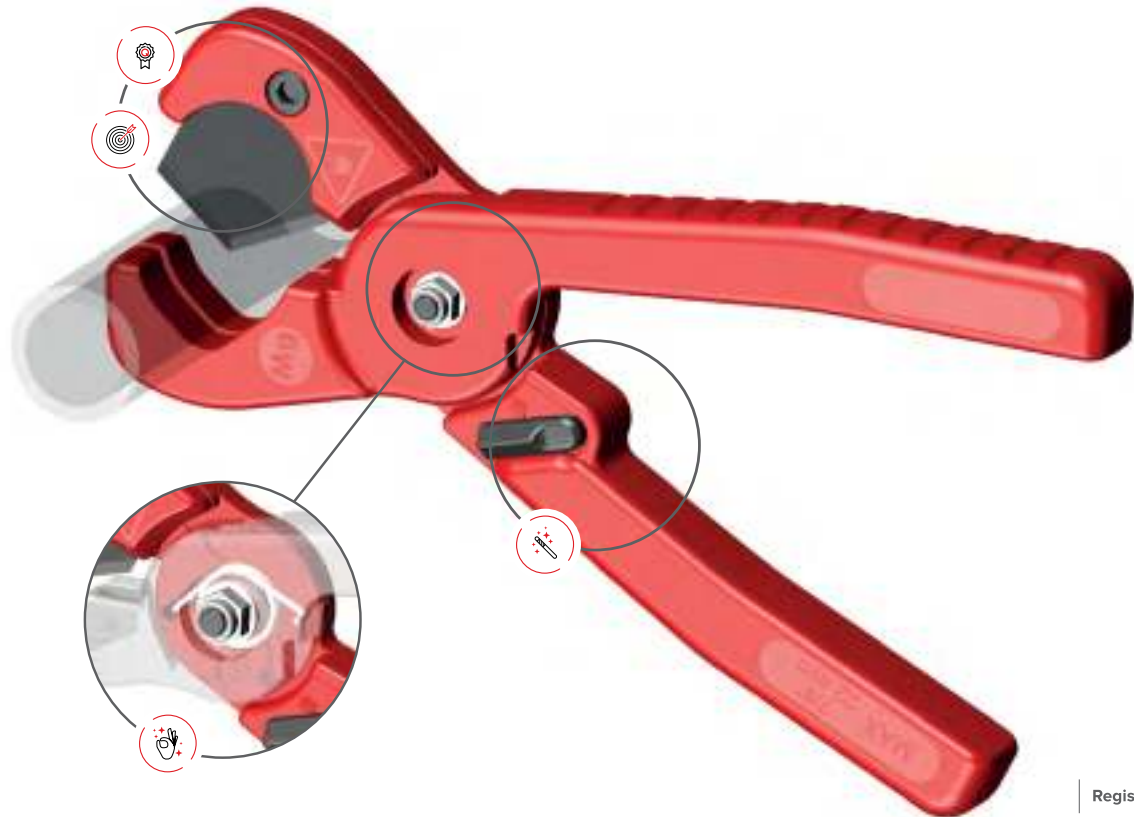

Registered Design



### Eficiente / Effizient / Efficient / Efficient

- Mínimo esfuerzo requerido para el corte.
- Minimale Anwendungskraft für den Schnitt.
- Minimal effort required for cutting.
- Minimum d'effort requis pour la coupe.



### Calidad / Qualität / Quality / Qualité

- Cuchilla "Made in Solingen / Germany". Geometría de corte especial y recubrimiento de PTFE.
- Klinge „Made in Solingen / Germany“. Optimale Schneidgeometrie und mit PTFE-Beschichtung.
- "Made in Solingen / Germany" blade. Special edge geometry and PTFE Coating.
- Lame "Made in Solingen / Germany". Géométrie de coupe spéciale et recouvrement de PTFE.



### Práctico / Praktisch / Practical / Pratique

- Retroceso de la cuchilla automático.
- Automatischer Klingenrückzug.
- Automatic blade release.
- Retour automatique de la lame.



### Útil / Handlich / Handy / Utile

- Sistema de cierre con una sola mano.
- Einhandverschlussystem.
- One handed locking system.
- Système de fermeture avec une seule main.



# 02

---

**Para mangueras flexibles, tubos de plástico de material blando y tubos de plástico de paredes delgadas**

**Für flexible Schläuche, weiche Kunststoffrohre und dünnwandige Kunststoffrohre**

**For flexible hoses, soft plastic tubes and thin walled plastic tubes**

**Pour tuyaux flexibles, tubes en plastique à matériel souple et tubes en plastique à paroi mince**

---

## MAGNESIUM

Para mangueras flexibles, tubos de plástico de material blando y tubos de plástico de paredes delgadas.

Für flexible Schläuche, weiche Kunststoffrohre und dünnwandige Kunststoffrohre.

For flexible hoses, soft plastic tubes and thin walled plastic tubes.

Pour tuyaux flexibles, tubes en plastique à matériel souple et tubes en plastique à paroi mince.

REF.	gr	DISPLAY		
5028-0	215	---	6	60
5028-1	230	•	5	60



+ PTFE

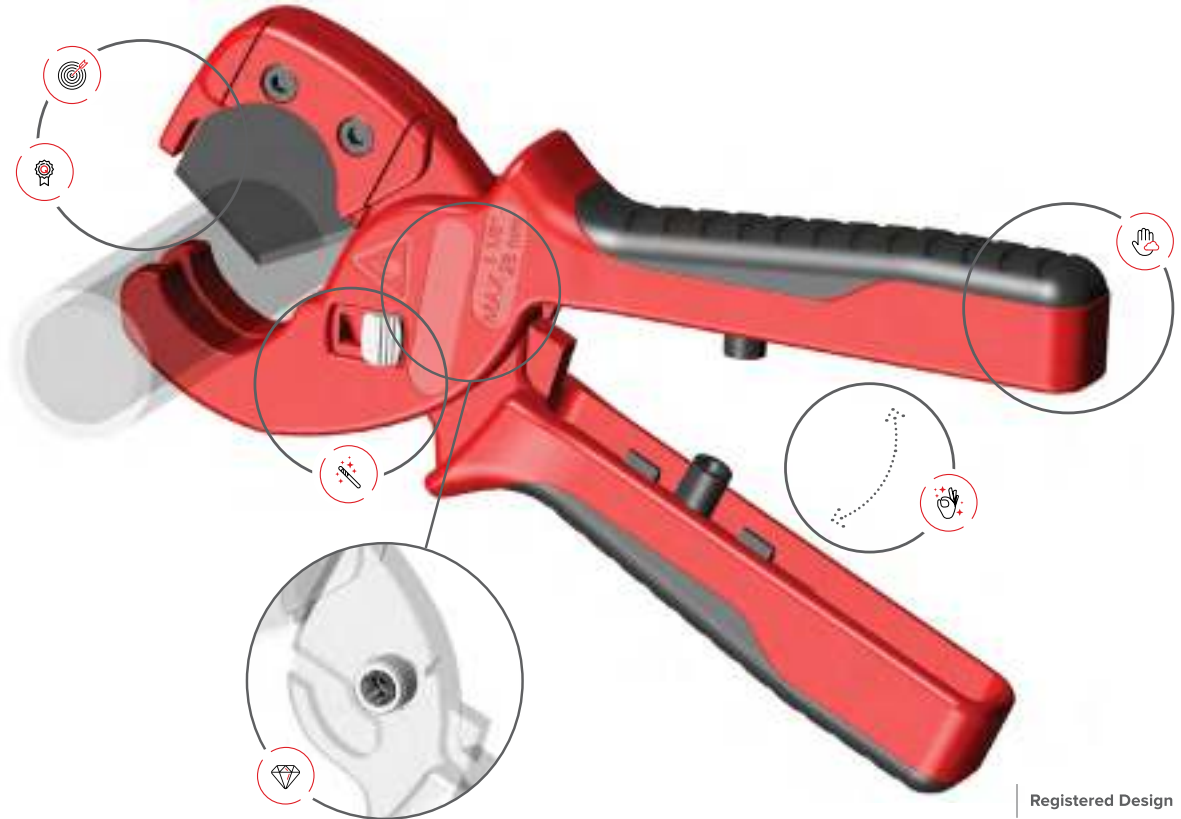

Registered Design



### Eficiente / Effizient / Efficient / Efficient

- Mínimo esfuerzo requerido para el corte.
- Minimale Anwendungskraft für den Schnitt.
- Minimal effort required for cutting.
- Minimum d'effort requis pour la coupe.



### Resistente / Resistent / Resistant / Résistant

- Sistema de giro con casquillo de acero y coronas de agujas.
- Rotations-System mit stahlgelagerter Achse mit Nadellager.
- Rotation system with steel socket equipped with needle bearings.
- Système de rotation avec frette en acier et cage à aiguilles.



### Calidad / Qualität / Quality / Qualité

- Cuchilla "Made in Solingen / Germany". Geometría de corte especial y recubrimiento de PTFE.
- Klinge „Made in Solingen / Germany“. Optimale Schneidgeometrie und mit PTFE-Beschichtung.
- "Made in Solingen / Germany" blade. Special edge geometry and PTFE Coating.
- Lame "Made in Solingen / Germany". Géométrie de coupe spéciale et recouvrement de PTFE.



### Práctico / Praktisch / Practical / Pratique

- Retroceso de la cuchilla automático.
- Automatischer Klängenrückzug.
- Automatic blade release.
- Retour automatique de la lame.



### Útil / Handlich / Handy / Utile

- Sistema de cierre con una sola mano.
- Einhandverschlussssystem.
- One handed locking system.
- Système de fermeture avec une seule main.



### Confort / Komfort / Comfort / Confort

- Empuñadura de goma con sistema anti-impactos.
- Zweikomponentengriff mit Anti-Impact Dämpfung.
- Rubber grip with anti-impact system.
- Poignée en gomme avec système anti-impacts.

## MAGNESIUM

Para tubos PEX  
Für PEX-Rohre  
For PEX tubes  
Pour tubes PEX

REF.	DISPLAY	6	60
5028-2	215	---	60
5028-3	230	•	60



5007-3

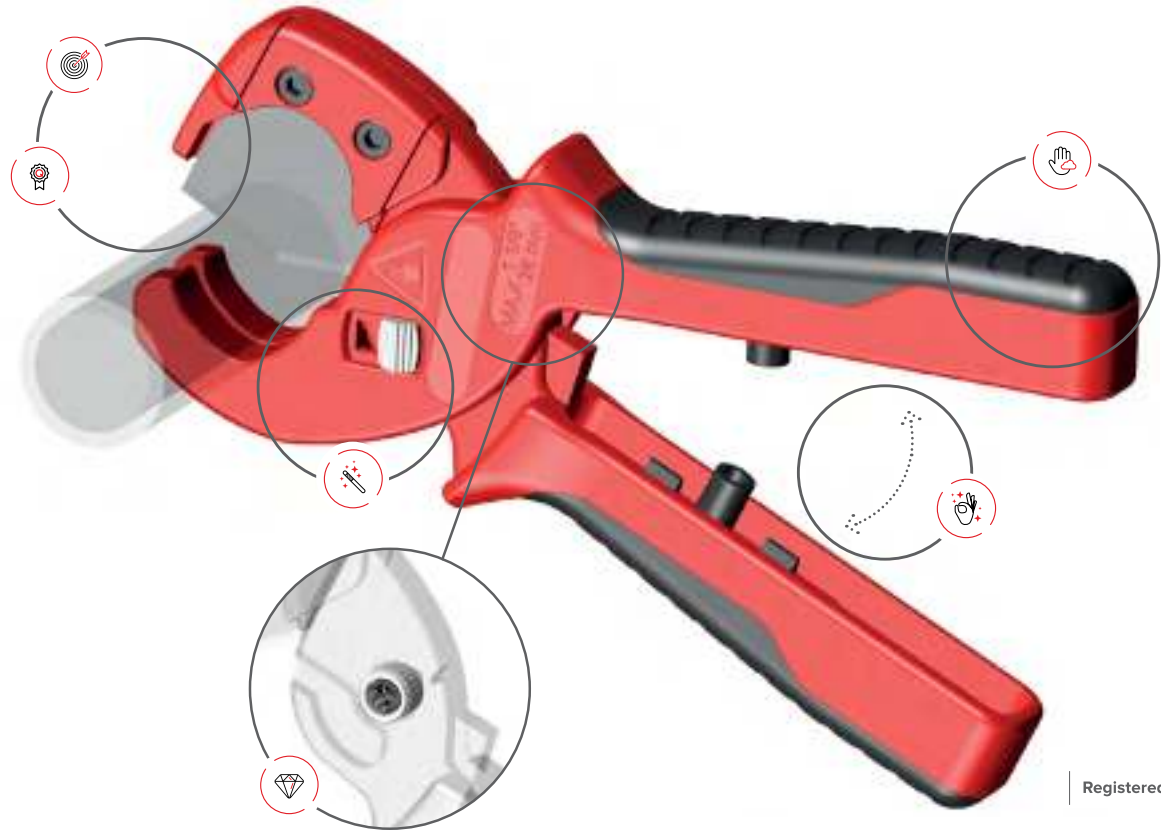

Registered Design



### Eficiente / Effizient / Efficient / Efficient

- Mínimo esfuerzo requerido para el corte.
- Minimale Anwendungskraft für den Schnitt.
- Minimal effort required for cutting.
- Minimum d'effort requis pour la coupe.



### Resistente / Resistent / Resistant / Résistant

- Sistema de giro con casquillo de acero y coronas de agujas.
- Rotations-System mit stahlgelagerter Achse mit Nadellager.
- Rotation system with steel socket equipped with needle bearings.
- Système de rotation avec frette en acier et cage à aiguilles.



### Calidad / Qualität / Quality / Qualité

- Cuchilla "Made in Solingen / Germany". Geometría de corte especial.
- Klinge „Made in Solingen / Germany“. Optimale Schneidgeometrie.
- "Made in Solingen / Germany" blade. Special edge geometry.
- Lame "Made in Solingen / Germany". Géométrie de coupe spéciale.



### Práctico / Praktisch / Practical / Pratique

- Retroceso de la cuchilla automático.
- Automatischer Klinsenrückzug.
- Automatic blade release.
- Retour automatique de la lame.



### Útil / Handlich / Handy / Utile

- Sistema de cierre con una sola mano.
- Einhandverschlussystem.
- One handed locking system.
- Système de fermeture avec une seule main.



### Confort / Komfort / Comfort / Confort

- Empuñadura de goma con sistema anti-impactos.
- Zweikomponentengriff mit Anti-Impact Dämpfung.
- Rubber grip with anti-impact system.
- Poignée en gomme avec système anti-impacts.





# 03

---

**Para tubos multicapa**  
**Für Verbundrohre**  
**For multilayer tubes**  
**Pour tubes multicouche**

---



**ZENTEN**

## MAGNESIUM

Para tubos multicapa.

Für Verbundrohre.

For multilayer tubes.

Pour tubes multicouche.

REF.	gr.	DISPLAY		
5226-0	235	----	5	50
5226-1	250	•	5	50

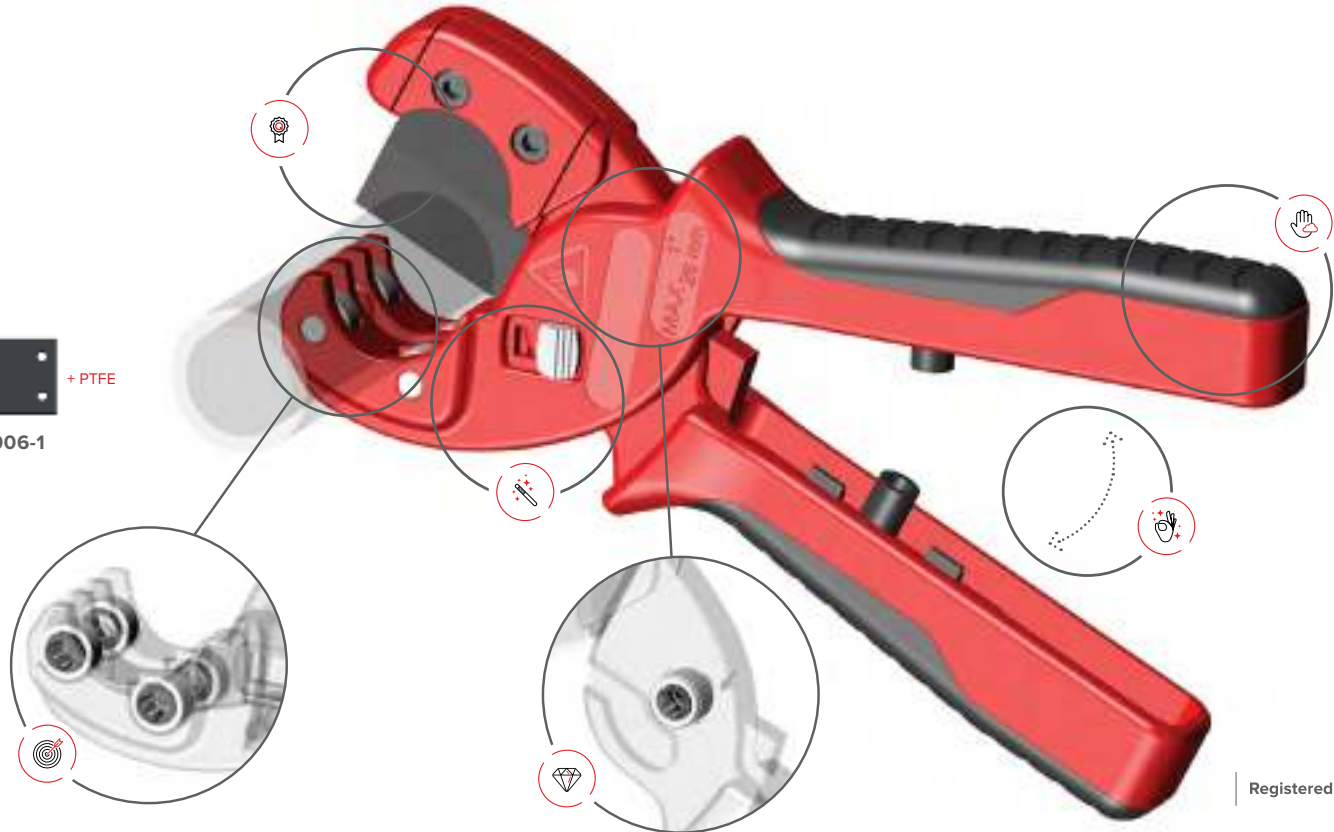

Registered Design



### Eficiente / Effizient / Efficient / Efficient

- Sistema "Twist&Cut". 4 rodillos con coronas de agujas facilitan el giro del tubo durante el corte.
- „Twist&Cut“-System. 4 nadelgelagerte Führungsrollen vereinfachen das Drehen des Rohres beim Schneiden.
- "Twist&Cut"-system. 4 rollers with needle bearings helping the turn of the tube during the cut.
- Système "Twist&Cut". 4 rouleaux équipés avec cages à aiguilles facilitent la rotation du tube pendant la coupe.



### Resistente / Resistent / Resistant / Résistant

- Sistema de giro con casquillo de acero y coronas de agujas.
- Rotations-System mit stahlgelagerter Achse mit Nadellager.
- Rotation system with steel socket equipped with needle bearings.
- Système de rotation avec frette en acier et cage à aiguilles.



### Calidad / Qualität / Quality / Qualité

- Cuchilla "Made in Solingen / Germany". Geometría de corte especial y recubrimiento de PTFE.
- Klinge „Made in Solingen / Germany“. Optimale Schneidgeometrie und mit PTFE-Beschichtung.
- "Made in Solingen / Germany" blade. Special edge geometry and PTFE Coating.
- Lame "Made in Solingen / Germany". Géométrie de coupe spéciale et recouvrement de PTFE.



### Práctico / Praktisch / Practical / Pratique

- Retroceso de la cuchilla automático.
- Automatischer Klingentrückzug.
- Automatic blade release.
- Retour automatique de la lame.



### Útil / Handlich / Handy / Utile

- Sistema de cierre con una sola mano.
- Einhandverschlussystem
- One handed locking system.
- Système de fermeture avec une seule main.



### Confort / Komfort / Comfort / Confort

- Empuñadura de goma con sistema anti-impactos.
- Zweikomponentengriff mit Anti-Impact Dämpfung.
- Rubber grip with anti-impact system.
- Poignée en gomme avec système anti-impacts.

## MAGNESIUM

Para tubos multicapa.

Für Verbundrohre.

For multilayer tubes.

Pour tubes multicouche.

REF.	gr.	DISPLAY		
5126-0	270	----	5	50
5126-1	285	•	5	50



+ PTFE

5006-1



+ PTFE

5008-1

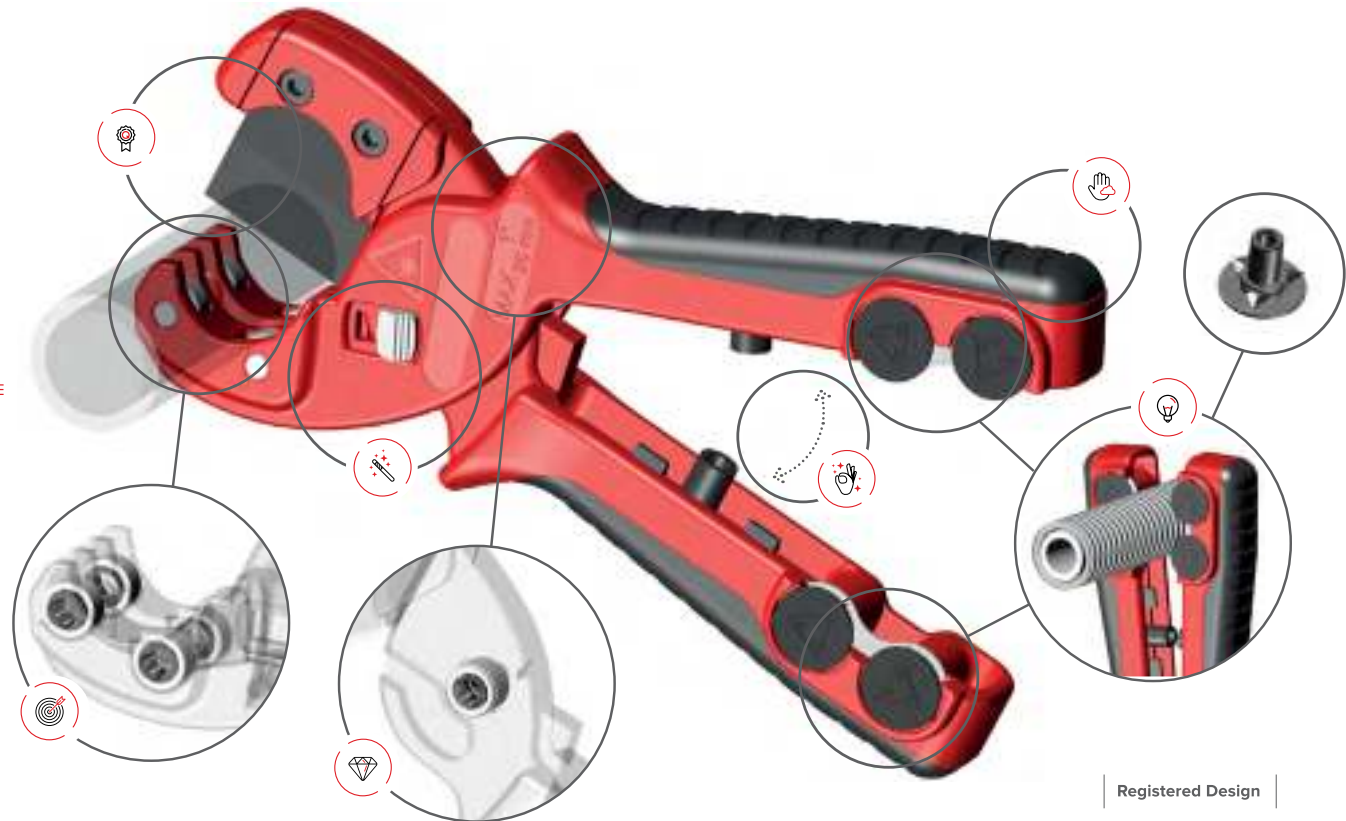

Registered Design



### Eficiente / Effizient / Efficient / Efficient

- Sistema "Twist&Cut". 4 rodillos con coronas de agujas facilitan el giro del tubo durante el corte.
- „Twist&Cut“-System. 4 nadelgelagerte Führungsrollen vereinfachen das Drehen des Rohres beim Schneiden.
- "Twist&Cut"-system. 4 rollers with needle bearings helping the turn of the tube during the cut.
- Système "Twist&Cut". 4 rouleaux équipés avec cages à aiguilles facilitent la rotation du tube pendant la coupe.



### Resistente / Resistent / Resistant / Résistant

- Sistema de giro con casquillo de acero y coronas de agujas.
- Rotations-System mit stahlgelagerter Achse mit Nadellager.
- Rotation system with steel socket equipped with needle bearings.
- Système de rotation avec frette en acier et cage à aiguilles.



### Calidad / Qualität / Quality / Qualität

- Cuchilla "Made in Solingen / Germany". Geometría de corte especial y recubrimiento de PTFE.
- Klinge „Made in Solingen / Germany“. Optimale Schneidgeometrie und mit PTFE-Beschichtung.
- "Made in Solingen / Germany" blade. Special edge geometry and PTFE Coating.
- Lame "Made in Solingen / Germany". Géométrie de coupe spéciale et recouvrement de PTFE.



### Solución / Lösung / Solution / Solution

- Sistema integrado para el corte de tubos corrugados de protección (18-35mm) sin dañar el tubo interior. Con 4 cuchillas con tres puntas. Se triplica la vida del sistema con solo girarlas 120°. Con recubrimiento PTFE.
- Integrierter Schutzwellrohrschneider. Schneiden des Schutzwellrohres (18-35mm) ohne das innere Rohr zu beschädigen. Mit 4 dreischneidigen Klingen. Dreimal längere Lebensdauer des Systems mit einer 120° Umdrehung der Klinge. Mit PTFE Beschichtung.
- Integrated cutting system for corrugated protected tubes (18-35MM). It allows cutting the protection tube without damaging the inner tube. With 4 three-edge blades. Three times longer life of the system turning the blades 120°. With PTFE-coating.
- Avec système intégré pour coupe de tubes annelés de protection (18-35mm) sans abîmer le tube intérieur. Avec 4 lames avec trois fils. Trois fois plus de durée du système avec un tour de 120° de la lame. Avec recouvrement de PTFE.



### Práctico / Praktisch / Practical / Pratique

- Retroceso de la cuchilla automático.
- Automatischer Klingentrückzug.
- Automatic blade release.
- Retour automatique de la lame.



### Útil / Handlich / Handy / Utile

- Sistema de cierre con una sola mano.
- Einhandverschlussystem.
- One handed locking system.
- Système de fermeture avec une seule main.



### Confort / Komfort / Comfort / Confort

- Empuñadura de goma con sistema anti-impactos.
- Zweikomponentengriff mit Anti-Impact Dämpfung.
- Rubber grip with anti-impact system.
- Poignée en gomme avec système anti-impacts.

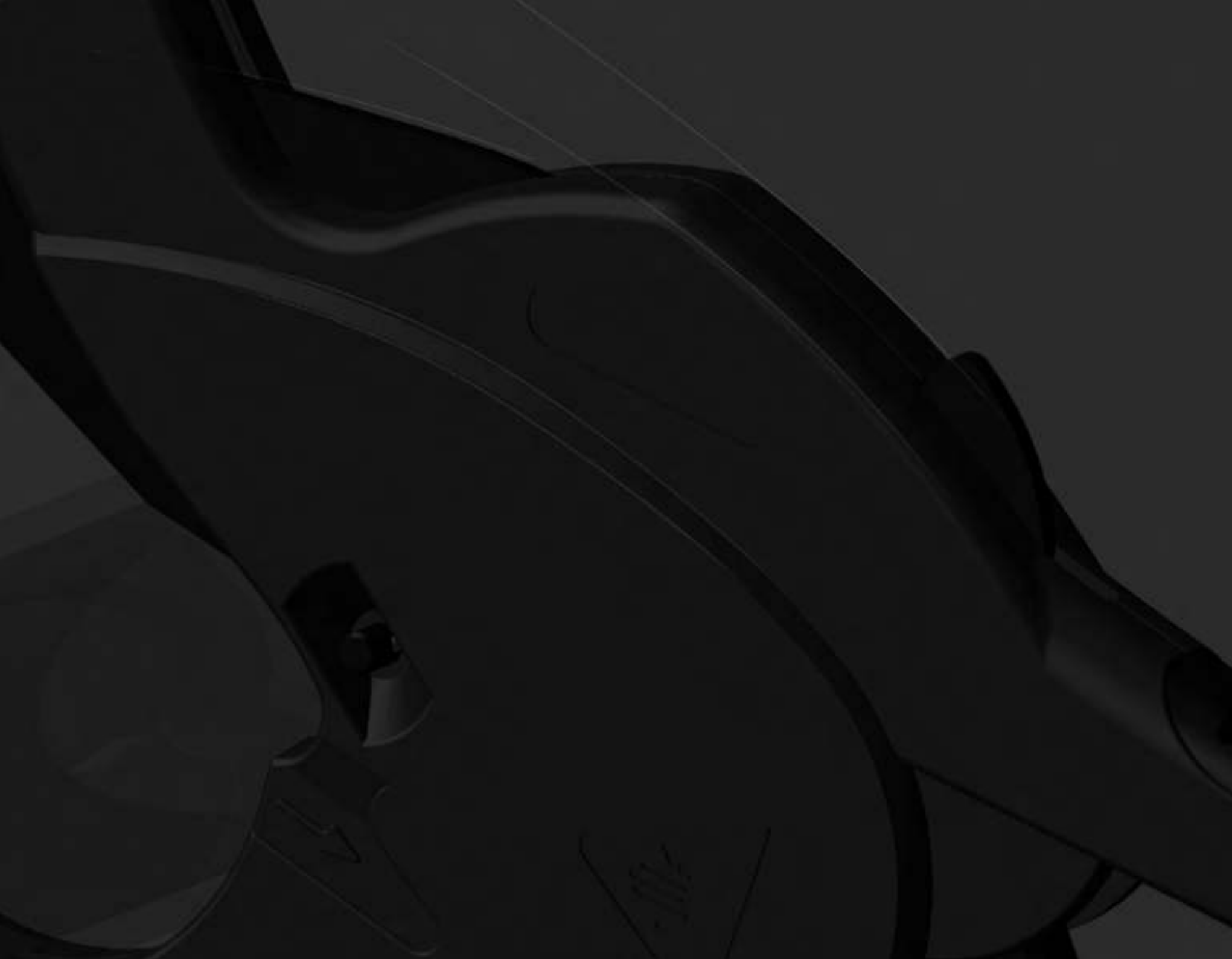

# 04

---

**Para tubos de plástico y multicapa**  
**Für Kunststoff- und Verbundrohre**  
**For plastic and multilayer tubes**  
**Pour tubes en plastique et multicouche**

---

ZENTEN



## MAGNESIUM

**Para tubos de plástico y multicapa.**  
**Für Kunststoff- und Verbundrohre.**  
**For plastic and multilayer tubes.**  
**Pour tubes en plastique et multicouche.**

PE, PP, PB, PEX,  
PPR, MLP/MSR, VPE,  
CPVC, PVC, PVDF



REF.	gr.	DISPLAY		
5026-0	235	----	5	50
5026-1	250	•	4	40



Registered Design



### Eficiente / Effizient / Efficient / Efficient

- Corte fácil, rápido y preciso. Mínimo esfuerzo requerido para el corte.
- Leichter, schneller und präziser Schnitt. Minimale Anwendungskraft für den Schnitt.
- Easy, straight and precise cut. Minimal effort required for cutting.
- Coupe facile, rapide et précise. Minimum d'effort requis pour la coupe.



### Instantáneo / Sofortiger / Instant / Instantané

- Sistema ICS (Instant Change System). Cambio de cuchilla instantáneo sin necesidad de herramienta.
- ICS-System (Instant Change System). Klingen-Schnellwechsel ohne Werkzeug.
- ICS-System (Instant Change System). No tool required for instant blade change.
- Système ICS (Instant Change System). Changement instantané de la lame sans besoin d'outil.



### Calidad / Qualität / Quality / Qualité

- Cuchilla INOX "Made in Solingen / Germany". Geometría de corte especial y recubrimiento PTFE.
- INOX-Klinge „Made in Solingen / Germany“. Optimale Schneidgeometrie und PTFE-Beschichtung.
- "Made in Solingen / Germany" stainless steel blade. Special edge geometry and PTFE coating.
- Lame INOX "Made in Solingen / Germany". Géométrie de coupe spéciale et recouvrement de PTFE.



### Práctico / Praktisch / Practical / Pratique

- Retroceso de la cuchilla automático.
- Automatischer Klingenrückzug.
- Automatic blade release.
- Retour automatique de la lame.

## MAGNESIUM

Para tubos de plástico y multicapa.

Für Kunststoff- und Verbundrohre.

For plastic and multilayer tubes.

Pour tubes en plastique et multicouche.

REF.	gr.	DISPLAY		
5035-0	270	----	5	50
5035-1	285	•	4	40

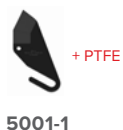

Registered Design



### Eficiente / Effizient / Efficient / Efficient

- Corte fácil, rápido y preciso. Mínimo esfuerzo requerido para el corte.
- Leichter, schneller und präziser Schnitt. Minimale Anwendungskraft für den Schnitt.
- Easy, straight and precise cut. Minimal effort required for cutting.
- Coupe facile, rapide et précise. Minimum d'effort requis pour la coupe.



### Instantáneo / Sofortiger / Instant / Instantané

- Sistema ICS (Instant Change System). Cambio de cuchilla instantáneo sin necesidad de herramienta.
- ICS-System (Instant Change System). Klingen-Schnellwechsel ohne Werkzeug.
- ICS-System (Instant Change System). No tool required for instant blade change.
- Système ICS (Instant Change System). Changement instantané de la lame sans besoin d'outil.



### Seguridad / Sicherheit / Safety / Sécurité

- Cuchilla recogida en el cuerpo. Evita daños en el filo de la cuchilla y lesiones al usuario.
- Klinge geschützt im Körper. Vermeidet Beschädigungen der Schneide und Verletzungen des Anwenders.
- Blade positioned within the body. No risk of blade damage or injury to the user.
- La lame reste gardée dans le corps. Ça évite des dommages dans la lame et des blessures aux utilisateurs.



### Calidad / Qualität / Quality / Qualité

- Cuchilla INOX "Made in Solingen / Germany". Geometría de corte especial y recubrimiento PTFE.
- INOX-Klinge „Made in Solingen / Germany“. Optimale Schneidgeometrie und PTFE-Beschichtung.
- "Made in Solingen / Germany" stainless steel blade. Special edge geometry and PTFE coating.
- Lame INOX "Made in Solingen / Germany". Géométrie de coupe spéciale et recouvrement de PTFE.



### Práctico / Praktisch / Practical / Pratique

- Retroceso de la cuchilla automático.
- Automatischer Klingenrückzug.
- Automatic blade release.
- Retour automatique de la lame.

## MAGNESIUM

Para tubos de plástico y multicapa.

Für Kunststoff- und Verbundrohre.

For plastic and multilayer tubes.

Pour tubes en plastique et multicouche.

REF.	Ø mm	gr.	DISPLAY		
5042-0	42	430	----	3	30
5042-1	42	455	•	6	18

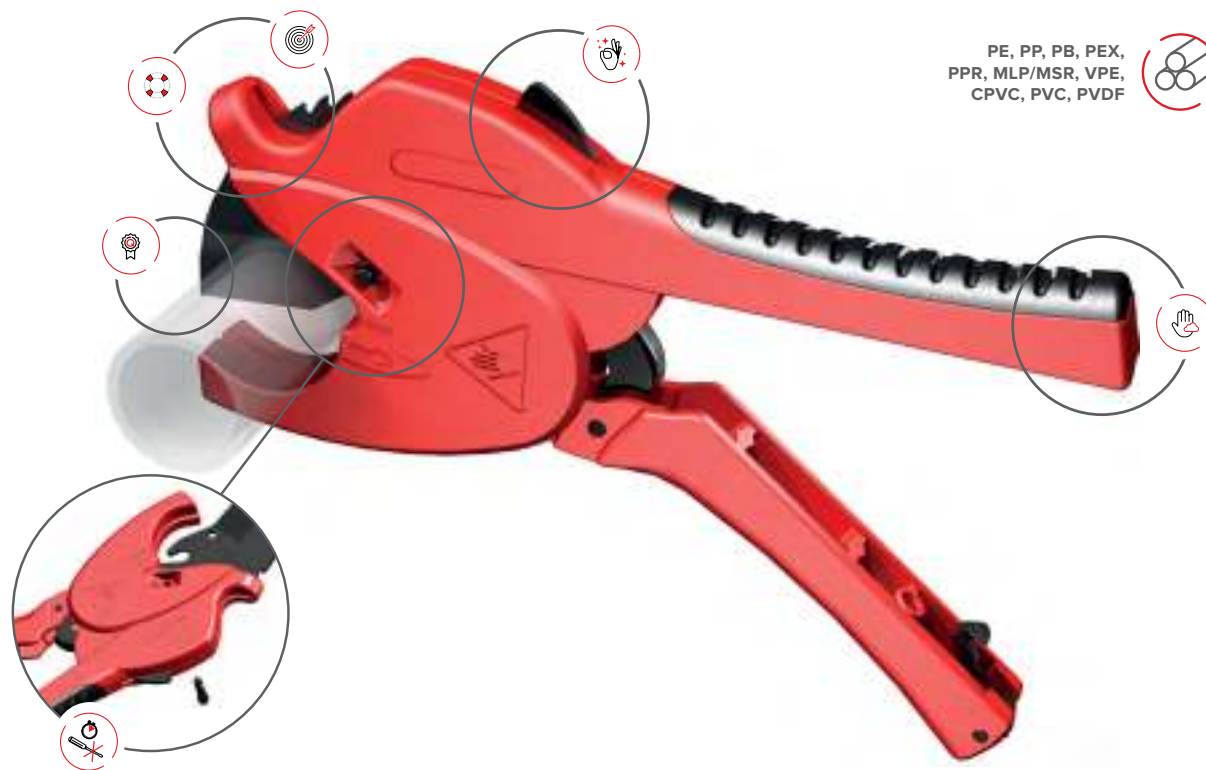
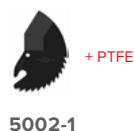

PE, PP, PB, PEX,  
PPR, MLP/MSR, VPE,  
CPVC, PVC, PVDF



Registered Design



### Eficiente / Effizient / Efficient / Efficient

- Corte fácil, rápido y preciso. Mínimo esfuerzo requerido mediante avance progresivo de la cuchilla.
- Leichter, schneller und präziser Schnitt. Minimale Anwendungskraft durch progressiven zahngeführten Klingenvorschub.
- Easy, straight and precise cut. Minimal effort required with advanced ratcheting system.
- Coupe facile, rapide et précise. Minimum d'effort requis par avancement progressif de la lame.



### Instantáneo / Sofortiger / Instant / Instantané

- Sistema ICS (Instant Change System). Cambio de cuchilla instantáneo sin necesidad de herramienta.
- ICS-System (Instant Change System). Klingen-Schnellwechsel ohne Werkzeug.
- ICS-System (Instant Change System). No tool required for instant blade change.
- Système ICS (Instant Change System). Changement instantané de la lame sans besoin d'outil.



### Seguridad / Sicherheit / Safety / Sécurité

- Cuchilla recogida en el cuerpo. Evita daños en el filo de la cuchilla y lesiones al usuario.
- Klinge geschützt im Körper. Vermeidet Beschädigungen der Schneide und Verletzungen des Anwenders.
- Blade positioned within the body. No risk of blade damage or injury to the user.
- La lame reste gardée dans le corps. Ça évite des dommages dans la lame et des blessures aux utilisateurs.



### Calidad / Qualität / Quality / Qualité

- Cuchilla INOX "Made in Solingen / Germany". Geometría de corte especial y recubrimiento PTFE.
- INOX-Klinge „Made in Solingen / Germany“. Optimale Schneidgeometrie und PTFE-Beschichtung.
- "Made in Solingen / Germany" stainless steel blade. Special edge geometry and PTFE coating.
- Lame INOX "Made in Solingen / Germany". Géométrie de coupe spéciale et recouvrement de PTFE.



### Práctico / Praktisch / Practical / Pratique

- Retrosceso de la cuchilla con una sola mano.
- Einhand-Schnellrückzug der Klinge.
- Quick one hand blade release.
- Retour de la lame avec une seule main.



### Confort / Komfort / Comfort / Confort

- Empuñadura de goma para un agarre seguro y confortable.
- Zweikomponentengriff. Liegt sicher und bequem in der Hand.
- Rubber grip. Cushion comfort grip.
- Poignée en gomme. Prise en main optimale. Confort maximum d'utilisation.



## MAGNESIUM

Para tubos de plástico y multicapa.

Für Kunststoff- und Verbundrohre.

For plastic and multilayer tubes.

Pour tubes en plastique et multicouche.

REF.	Ø mm	gr.	DISPLAY		
5050-0	50	455	----	3	30
5050-1	50	480	•	6	18

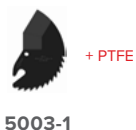

PE, PP, PB, PEX,  
PPR, MLP/MSR, VPE,  
CPVC, PVC, PVDF

Registered Design



### Eficiente / Effizient / Efficient / Efficient

- Corte fácil, rápido y preciso. Mínimo esfuerzo requerido mediante avance progresivo de la cuchilla.
- Leichter, schneller und präziser Schnitt. Minimale Anwendungskraft durch progressiven zahngeführten Klingenvorschub.
- Easy, straight and precise cut. Minimal effort required with advanced ratcheting system.
- Coupe facile, rapide et précise. Minimum d'effort requis par avancement progressif de la lame.



### Instantáneo / Sofortiger / Instant / Instantané

- Sistema ICS (Instant Change System). Cambio de cuchilla instantáneo sin necesidad de herramienta.
- ICS-System (Instant Change System). Klängen-Schnellwechsel ohne Werkzeug.
- ICS-System (Instant Change System). No tool required for instant blade change.
- Système ICS (Instant Change System). Changement instantané de la lame sans besoin d'outil.



### Seguridad / Sicherheit / Safety / Sécurité

- Cuchilla recogida en el cuerpo. Evita daños en el filo de la cuchilla y lesiones al usuario.
- Klinge geschützt im Körper. Vermeidet Beschädigungen der Schneide und Verletzungen des Anwenders.
- Blade positioned within the body. No risk of blade damage or injury to the user.
- La lame reste gardée dans le corps. Ça évite des dommages dans la lame et des blessures aux utilisateurs.



### Calidad / Qualität / Quality / Qualité

- Cuchilla INOX "Made in Solingen / Germany". Geometría de corte especial y recubrimiento PTFE.
- INOX-Klinge „Made in Solingen / Germany“. Optimale Schneidgeometrie und PTFE-Beschichtung.
- "Made in Solingen / Germany" stainless steel blade. Special edge geometry and PTFE coating.
- Lame INOX "Made in Solingen / Germany". Géométrie de coupe spéciale et recouvrement de PTFE.



### Práctico / Praktisch / Practical / Pratique

- Retroceso de la cuchilla con una sola mano.
- Einhand-Schnellrückzug der Klinge.
- Quick one hand blade release.
- Retour de la lame avec une seule main.



### Confort / Komfort / Comfort / Confort

- Empuñadura de goma para un agarre seguro y confortable.
- Zweikomponentengriff. Liegt sicher und bequem in der Hand.
- Rubber grip. Cushion comfort grip.
- Poignée en gomme. Prise en main optimale. Confort maximum d'utilisation.

## MAGNESIUM

**Para tubos de plástico y multicapa.**  
**Für Kunststoff- und Verbundrohre.**  
**For plastic and multilayer tubes.**  
**Pour tubes en plastique et multicouche.**

REF.	gr.	DISPLAY		
5063-0	610	----	6	18
5063-1	645	•	5	15



+ PTFE

5004-1

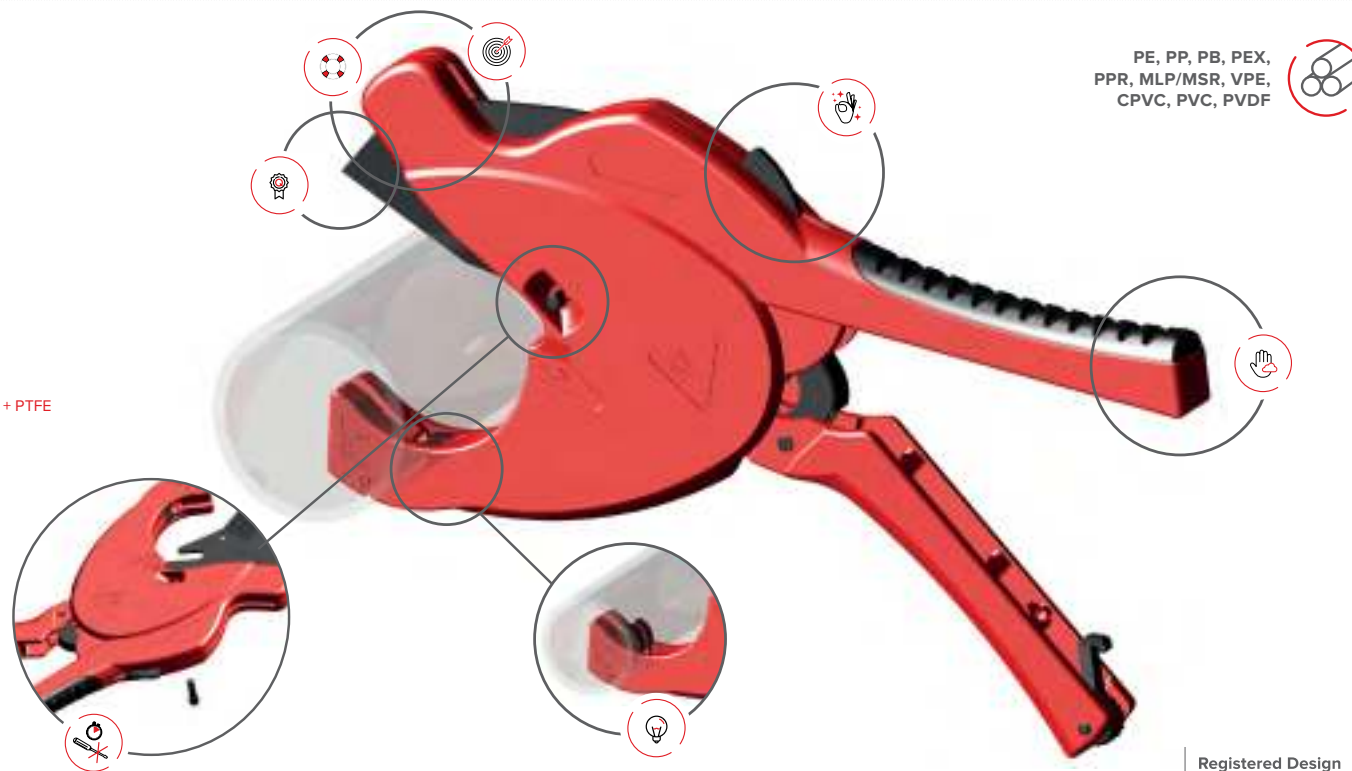

PE, PP, PB, PEX,  
PPR, MLP/MSR, VPE,  
CPVC, PVC, PVDF

Registered Design



### Efficiente / Effizient / Efficient / Efficient

- Corte fácil, rápido y preciso. Mínimo esfuerzo requerido mediante avance progresivo de la cuchilla.
- Leichter, schneller und präziser Schnitt. Minimale Anwendungskraft durch progressive zahngeführten Klingenvorschub.
- Easy, straight and precise cut. Minimal effort required with advanced ratcheting system.
- Coupe facile, rapide et précise. Minimum d'effort requis par avancement progressif de la lame.



### Solución / Lösung / Solution / Solution

- Con sistema de alineación para tubos hasta 50mm. Mejor corte.
- Verstellbares Rohranäherungssystem für Rohre bis 50mm. Besserer Schnitt.
- Adjustable tube approach-system for tubes up to 50mm. Better cup.
- Système d'alignement du tube jusqu'à 50mm. Meilleure coupe.



### Instantáneo / Sofortiger / Instant / Instantané

- Sistema ICS (Instant Change System). Cambio de cuchilla instantáneo sin necesidad de herramienta.
- ICS-System (Instant Change System). Klängen-Schnellwechsel ohne Werkzeug.
- ICS-System (Instant Change System). No tool required for instant blade change.
- Système ICS (Instant Change System). Changement instantané de la lame sans besoin d'outil.



### Seguridad / Sicherheit / Safety / Sécurité

- Cuchilla recogida en el cuerpo. Evita daños en el filo de la cuchilla y lesiones al usuario.
- Klinge geschützt im Körper. Vermeidet Beschädigungen der Schneide und Verletzungen des Anwenders.
- Blade positioned within the body. No risk of blade damage or injury to the user.
- La lame reste gardée dans le corps. Ça évite des dommages dans la lame et des blessures aux utilisateurs.



### Calidad / Qualität / Quality / Qualité

- Cuchilla INOX "Made in Solingen / Germany". Geometría de corte especial y recubrimiento PTFE.
- INOX-Klinge „Made in Solingen / Germany“. Optimale Schneidengeometrie und PTFE-Beschichtung.
- "Made in Solingen / Germany" stainless steel blade. Special edge geometry and PTFE coating.
- Lame INOX "Made in Solingen / Germany". Géométrie de coupe spéciale et recouvrement de PTFE.



### Práctico / Praktisch / Practical / Pratique

- Retroceso de la cuchilla con una sola mano.
- Einhand-Schnellrückzug der Klinge.
- Quick one hand blade release.
- Retour de la lame avec une seule main.



### Confort / Komfort / Comfort / Confort

- Empuñadura de goma para un agarre seguro y confortable.
- Zweikomponentengriff. Liegt sicher und bequem in der Hand.
- Rubber grip. Cushion comfort grip.
- Poignée en gomme. Prise en main optimale. Confort maximum d'utilisation.

# kompakt+ ptquick

MODEL 7476

Ø 1/4"-3" (6-76mm)

Para tubos de plástico y multicapa.

Für Kunststoff- und Verbundrohre.

For plastic and multilayer tubes.

Pour tubes en plastique et multicouche.

REF.	Ø mm		gr.	DISPLAY		
7476-8	6-76	2x	880	----	1	15
7476-9	6-76	2x	905	•	0	12



**6017-0**  
30x6,20mm

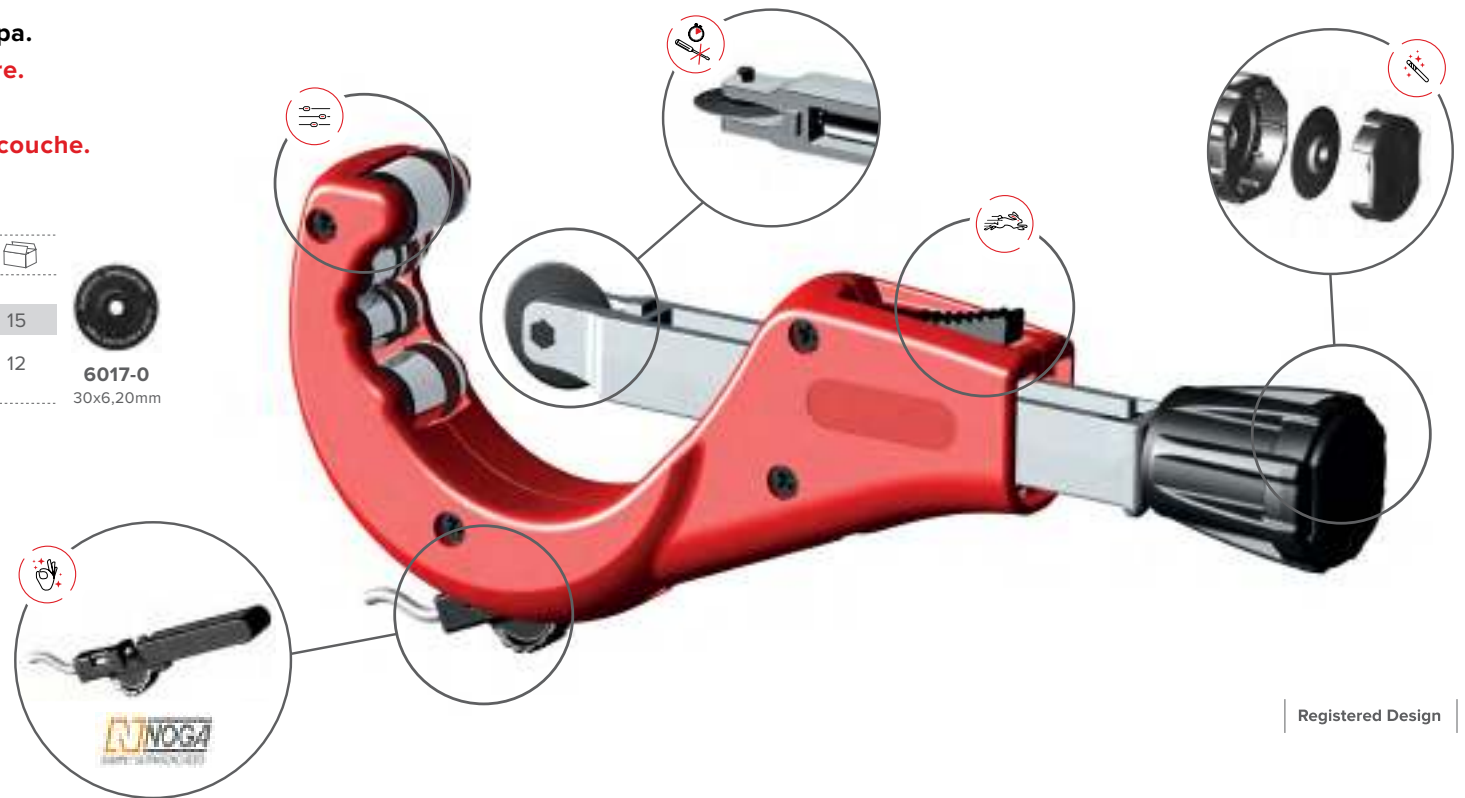

Registered Design



## Rápido / Schnell / Quick / Rapide

- Sistema de avance rápido.
- Schnell-Vorschub System.
- Quick-release system.
- Système d'avance rapide.



## Instantáneo / Sofortiger / Instant / Instantané

- Sistema ICS (Instant Change System). Cambio de cuchilla instantáneo sin necesidad de herramienta.
- ICS-System (Instant Change System). Schneidrädchen-Schnellwechsel ohne Werkzeug.
- ICS-System (Instant Change System). No tool required for instant wheel change.
- Système ICS (Instant Change System). Changement instantané de la molette sans besoin d'outil.



## Estable / Stabil / Stable / Stable

- 4 rodillos para un mejor agarre del tubo.
- 4 Führungsrollen für einen optimalen Halt des Rohres.
- 4 rollers for a better fastening of the tube.
- 4 rouleaux pour un meilleur accrochage du tube.



## Práctico / Praktisch / Practical / Pratique

- Rebabador NOGA completamente extraíble.
- NOGA Entgrater-Klinge. Kann komplett herausgezogen werden.
- Complete removable NOGA reamer.
- Ébavureur NOGA complètement extractible.



## Útil / Handlich / Handy / Utile

- Cuchilla de recambio en la tapa del pomo.
- Ersatzrädchen in Drehknopf-Kappe.
- Spare cutting wheel on the cap of the knob.
- Molette de rechange dans le bouchon du pommeau.

# kompakt+ ptquick

MODEL 7477  
Ø 2"-5" (50-127mm)

Para tubos de plástico y multicapa.

Für Kunststoff- und Verbundrohre.

For plastic and multilayer tubes.

Pour tubes en plastique et multicouche.

Registered Design

REF. Ø mm 1x 11,8 1620 1 6

7477-2 50-127 1x 11,8 1620 1 6

7477-3 50-127 1x 11,8 1620 1 6

7477-4 50-127 1x 16,8 1625 1 6

7477-5 50-127 1x 16,8 1625 1 6

7487-4 50-127 1x 16,8 1625 1 6

7487-5 50-127 1x 16,8 1625 1 6

7477-6 50-127 1x 19,8 1630 1 6

7477-7 50-127 1x 19,8 1630 1 6

7477-8 50-127 1x 27,8 1655 1 6

7477-9 50-127 1x 27,8 1655 1 6

+ PTFE

7403-0  
35x11mm

+ PTFE

7404-0  
45x11mm

7407-0  
45x11mm

+ PTFE

7405-0  
51x11mm

+ PTFE

7406-0  
67x11mm

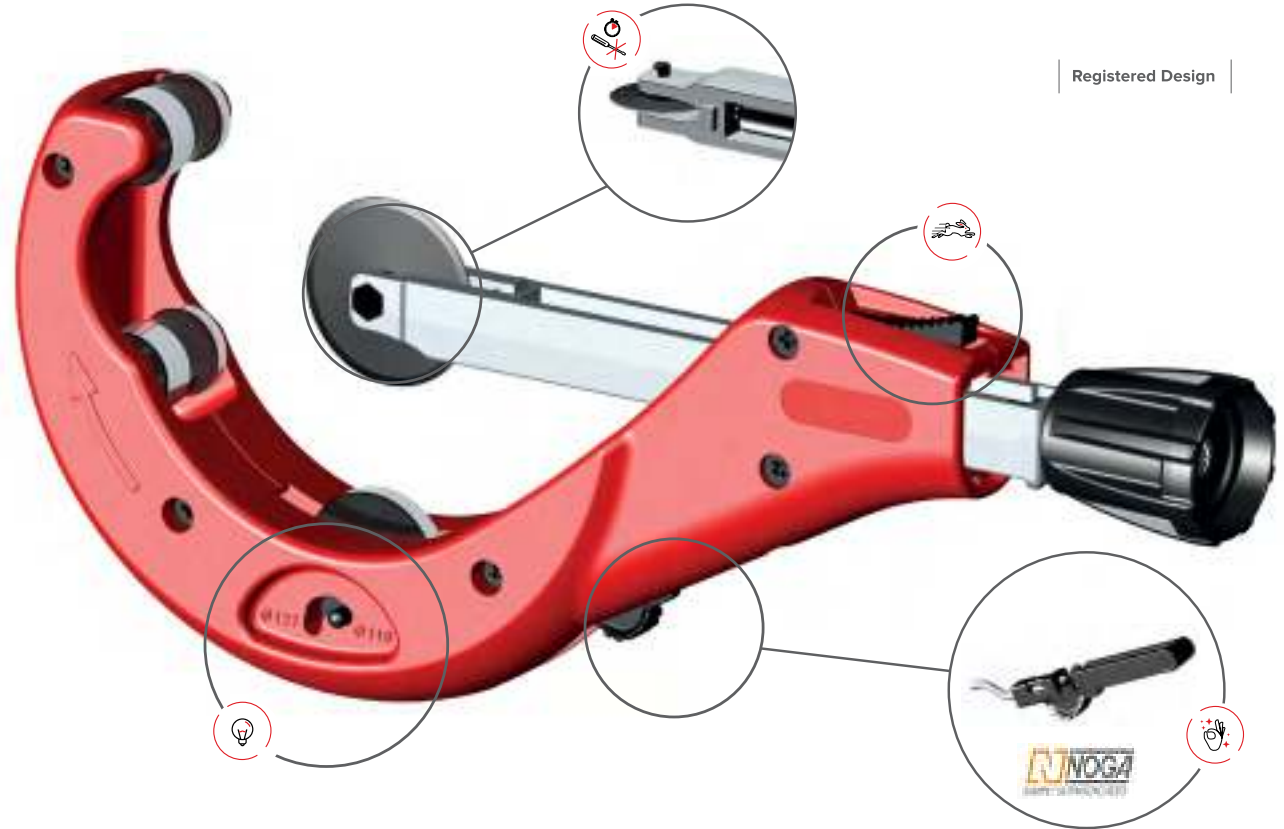

## Solución / Lösung / Solution / Solution

- Tercer rodillo regulable en dos posiciones (110mm y 127mm). Mejor guiado del tubo durante el corte.
- Posición 110mm: para cortar tubos hasta 110mm.
- Posición 127mm: para cortar tubos a partir de 110mm hasta 127mm.

- In zwei Positionen (110mm und 127mm) verstellbare dritte Führungsrolle für eine optimale Führung des Rohres beim Schneiden.
- Position 110mm: Zum Schneiden von Rohren bis inklusive 110mm.
- Position 127mm: Zum Schneiden von Rohren ab 110mm und bis 127mm.

- Adjustable third roller in 2 positions (110mm and 127mm) for a better guiding of the tube while cutting.
- 110mm position: to cut tubes up to 110mm.
- 127mm position: to cut tubes from 110mm up to 127mm.

- Troisième rouleau réglable en 2 positions (110mm et 127mm) pour un meilleur guidage du tube lors de la coupe.
- Position 110mm: pour couper des tubes jusqu'à 110mm.
- Position 127mm: pour couper des tubes a partir de 110mm jusqu'à 127mm.



## Rápido / Schnell / Quick / Rapide

- Sistema de avance rápido.
- Schnell-Vorschub System.
- Quick-release system.
- Système d'avance rapide.



## Instantáneo / Sofortiger / Instant / Instantané

- Sistema ICS (Instant Change System). Cambio de cuchilla instantáneo sin necesidad de herramienta.
- ICS-System (Instant Change System). Schneidrädchen-Schnellwechsel ohne Werkzeug.
- ICS-System (Instant Change System). No tool required for instant wheel change.
- Système ICS (Instant Change System). Changement instantané de la molette sans besoin d'outil.



## Práctico / Praktisch / Practical / Pratique

- Rebabador NOGA completamente extraíble.
- NOGA Entgrater-Klinge. Kann komplett herausgezogen werden.
- Complete removable NOGA professional reamer.
- Ébavureur NOGA complètement extractible.

Para tubos de plástico y multicapa.

Für Kunststoff- und Verbundrohre.

For plastic and multilayer tubes.

Pour tubes en plastique et multicouche.

Registered Design

REF.	Ø mm		mm	gr.			
7478-2	100-170	1x	11,8	1830	1	6	+ PTFE 7403-0 35x11mm
7478-3	100-170	1x	11,8	1830	1	6	
7478-4	100-170	1x	16,8	1835	1	6	+ PTFE 7404-0 45x11mm
7478-5	100-170	1x	16,8	1835	1	6	
7488-4	100-170	1x	16,8	1835	1	6	
7488-5	100-170	1x	16,8	1835	1	6	+ PTFE 7407-0 45x11mm
7478-6	100-170	1x	19,8	1840	1	6	+ PTFE 7405-0 51x11mm
7478-7	100-170	1x	19,8	1840	1	6	
7478-8	100-170	1x	27,8	1865	1	6	+ PTFE 7406-0 67x11mm
7478-9	100-170	1x	27,8	1865	1	6	

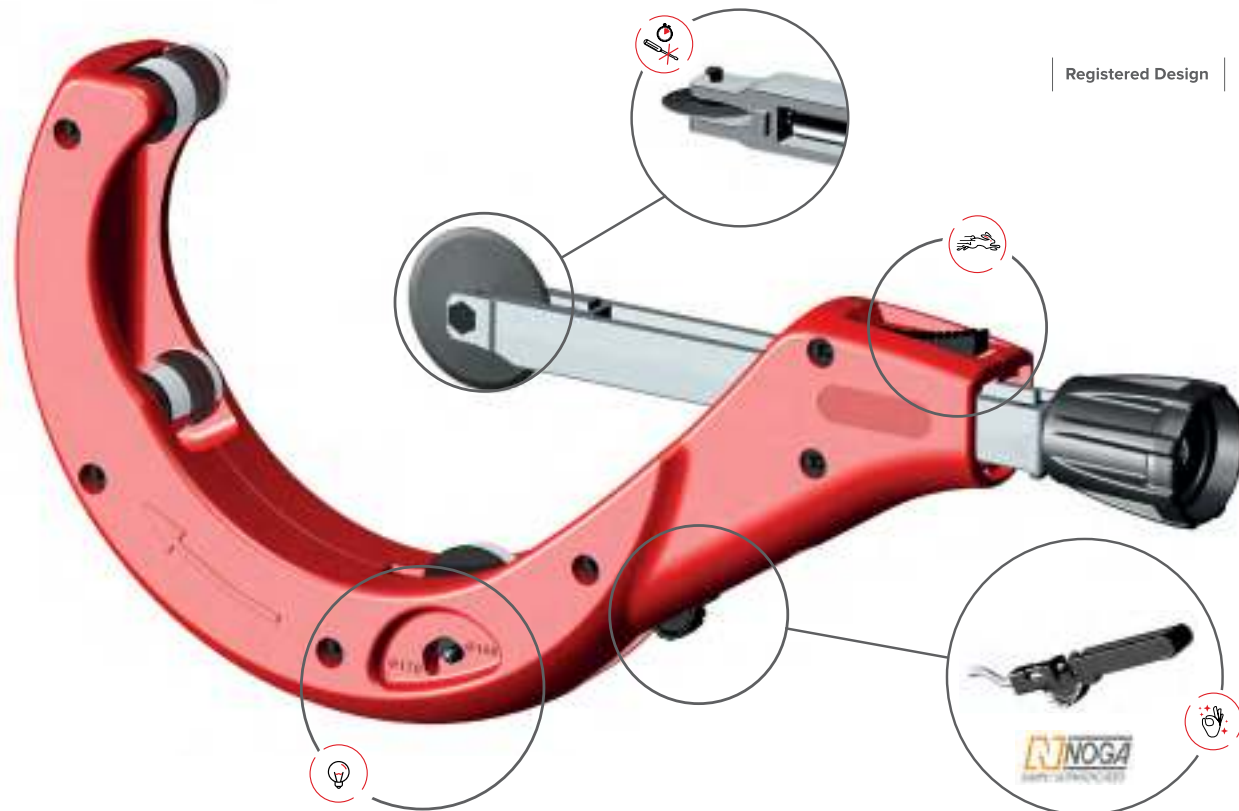

#### Solución / Lösung / Solution / Solution

- Tercer rodillo regulable en dos posiciones (160mm y 170mm). Mejor guiado del tubo durante el corte.
- Posición 160mm: para cortar tubos hasta 160mm.
- Posición 170mm: para cortar tubos a partir de 160mm hasta 170mm.

• In zwei Positionen (160mm und 170mm) verstellbare dritte Führungsrolle für eine optimale Führung des Rohres beim Schneiden.

- Position 160mm: Zum Schneiden von Rohren bis inklusive 160mm.
- Position 170mm: Zum Schneiden von Rohren ab 160mm und bis 170mm.

• Adjustable third roller in 2 positions (160mm and 170mm) for a better guiding of the tube while cutting.

- 160mm position: to cut tubes up to 160mm.
- 170mm position: to cut tubes from 160mm up to 170mm.

• Troisième rouleur réglable en 2 positions (160mm et 170mm) pour un meilleur guidage du tube lors de la coupe.

- Position 160mm: pour couper des tubes jusqu'à 160mm.
- Position 170mm: pour couper des tubes a partir de 160mm jusqu'à 170mm



#### Rápido / Schnell / Quick / Rapide

- Sistema de avance rápido.
- Schnell-Vorschub System.
- Quick-release system.
- Système d'avance rapide.



#### Instantáneo / Sofortiger / Instant / Instantané

- Sistema ICS (Instant Change System). Cambio de cuchilla instantáneo sin necesidad de herramienta.
- ICS-System (Instant Change System). Schneidrädchen-Schnellwechsel ohne Werkzeug.
- ICS-System (Instant Change System). No tool required for instant wheel change.
- Système ICS (Instant Change System). Changement instantané de la molette sans besoin d'outil.



#### Práctico / Praktisch / Practical / Pratique

- Rebabador NOGA completamente extraíble.
- NOGA Entgrater-Klinge. Kann komplett herausgezogen werden.
- Complete removable NOGA professional reamer.
- Ébavureur NOGA complètement extractible.



# 05

---

**Para tubos metálicos de pared delgada**  
**Für dünnwandige Metallrohre**  
**For thin metal tubes**  
**Pour tubes métalliques à paroi mince**

---

ZENTEN

Para tubos metálicos de pared delgada.

Für dünnwandige Metallrohre.

For thin metal tubes.

Pour tubes métalliques à paroi mince.

## AL, CU & INOX (MAX. 2 mm)

REF.	Ø mm			DISPLAY		
7016-0	3-16	1x	105	-----	50	150
7016-1	3-16	1x	110	•	10	100

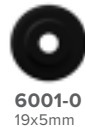

7316-0	3-16	1x	105	-----	50	150
7316-1	3-16	1x	110	•	10	100



## AL, CU (MAX. 2 mm)

7016-2	3-16	1x	105	-----	50	150
7016-3	3-16	1x	110	•	10	100



7316-2	3-16	1x	105	-----	50	150
7316-3	3-16	1x	110	•	10	100



Registered Design



### Resistente / Resistent / Resistant / Résistant

- Desplazamiento del eje a través de casquillo de acero roscado.
- Stahlgelagerte Spindel.
- Threading of feed screw on steel socket.
- Déplacement de l'axe à travers une frette en acier.



### Instantáneo / Sofortiger / Instant / Instantané

- Sistema ICS (Instant Change System). Cambio de cuchilla instantáneo sin necesidad de herramienta.
- ICS-System (Instant Change System). Schneidrädchen-Schnellwechsel ohne Werkzeug.
- ICS-System (Instant Change System). No tool required for instant wheel change.
- Système ICS (Instant Change System). Changement instantané de la molette sans besoin d'outil.



### Confort / Komfort / Comfort / Confort

- Pomo ergonómico.
- Ergonomischer Drehknopf.
- Ergonomic knob.
- Pommeau ergonomique.



### Solución / Lösung / Solution / Solution

- Radio de trabajo extra reducido.
- Mit extrem reduziertem Arbeitsradius.
- Extra reduced radius spin.
- Rayon de travail extra réduit.



Para tubos metálicos de pared delgada.

Für dünnwandige Metallrohre.

For thin metal tubes.

Pour tubes métalliques à paroi mince.

## AL, CU & INOX (MAX. 2 mm)

REF.	Ø mm			DISPLAY		
7025-0	3-25	1x	140	----	30	120
7025-1	3-25	1x	145	•	10	100



**6001-0**  
19x5mm

7325-0	3-25	1x	140	----	30	120
7325-1	3-25	1x	145	•	10	100



**6005-0**  
19x6,20mm

## AL, CU (MAX. 2 mm)

7025-2	3-25	1x	140	----	30	120
7025-3	3-25	1x	145	•	10	100



**6008-0**  
19x5mm

7325-2	3-25	1x	140	----	30	120
7325-3	3-25	1x	145	•	10	100



**6009-0**  
19x6,20mm



Registered Design



### Resistente / Resistent / Resistant / Résistant

- Desplazamiento del eje a través de casquillo de acero roscado.
- Stahlgelagerte Spindel.
- Threading of feed screw on steel socket.
- Déplacement de l'axe à travers une frette en acier.



### Instantáneo / Sofortiger / Instant / Instantané

- Sistema ICS (Instant Change System). Cambio de cuchilla instantáneo sin necesidad de herramienta.
- ICS-System (Instant Change System). Schneidrädchen-Schnellwechsel ohne Werkzeug.
- ICS-System (Instant Change System). No tool required for instant wheel change.
- Système ICS (Instant Change System). Changement instantané de la molette sans besoin d'outil.



### Confort / Komfort / Comfort / Confort

- Pomo ergonómico.
- Ergonomischer Drehknopf.
- Ergonomic knob.
- Pommeau ergonomique.



### Solución / Lösung / Solution / Solution

- Radio de trabajo extra reducido.
- Mit extrem reduziertem Arbeitsradius.
- Extra reduced radius spin.
- Rayon de travail extra réduit.

Para tubos metálicos de pared delgada.

Für dünnwandige Metallrohre.

For thin metal tubes.

Pour tubes métalliques à paroi mince.

## AL, CU & INOX (MAX. 2 mm)

REF.	Ø mm		gr.	DISPLAY		
7030-0	3-30	1x	340	----	10	40
7030-1	3-30	1x	350	•	5	50



**6001-0**  
19x5mm



**6005-0**  
19x6,20mm

## AL, CU (MAX. 2 mm)

7030-2	3-30	1x	340	----	10	40
7030-3	3-30	1x	350	•	5	50

7330-2	3-30	1x	340	----	10	40
7330-3	3-30	1x	350	•	5	50



**6008-0**  
19x5mm



**6009-0**  
19x6,20mm

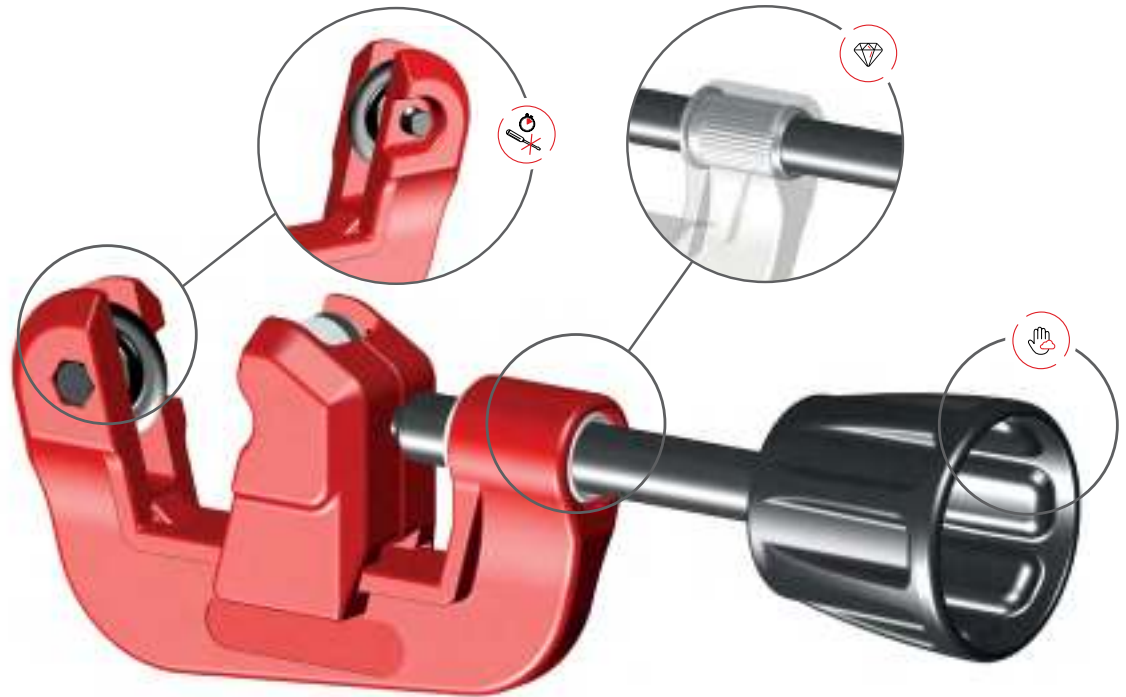

Registered Design



### Resistente / Resistent / Resistant / Résistant

- Desplazamiento del eje a través de casquillo de acero roscado.
- Stahlgelagerte Spindel.
- Threading of feed screw on steel socket.
- Déplacement de l'axe à travers une frette en acier.



### Instantáneo / Sofortiger / Instant / Instantané

- Sistema ICS (Instant Change System). Cambio de cuchilla instantáneo sin necesidad de herramienta.
- ICS-System (Instant Change System). Schneidrädchen-Schnellwechsel ohne Werkzeug.
- ICS-System (Instant Change System). No tool required for instant wheel change.
- Système ICS (Instant Change System). Changement instantané de la molette sans besoin d'outil.



### Confort / Komfort / Comfort / Confort

- Pomo ergonómico.
- Ergonomischer Drehknopf.
- Ergonomic knob.
- Pommeau ergonomique.

Para tubos metálicos de pared delgada.

Für dünnwandige Metallrohre.

For thin metal tubes.

Pour tubes métalliques à paroi mince.

## AL, CU & INOX (MAX. 2 mm)

REF.	Ø mm			DISPLAY		
7035-0	3-35	1x	345	----	10	40
7035-1	3-35	1x	355	•	5	50



**6001-0**  
19x5mm



**6005-0**  
19x6,20mm

## AL, CU (MAX. 2 mm)

7035-2	3-35	1x	345	----	10	40
7035-3	3-35	1x	355	•	5	50
7335-2	3-35	1x	345	----	10	40
7335-3	3-35	1x	355	•	5	50



**6008-0**  
19x5mm



**6009-0**  
19x6,20mm

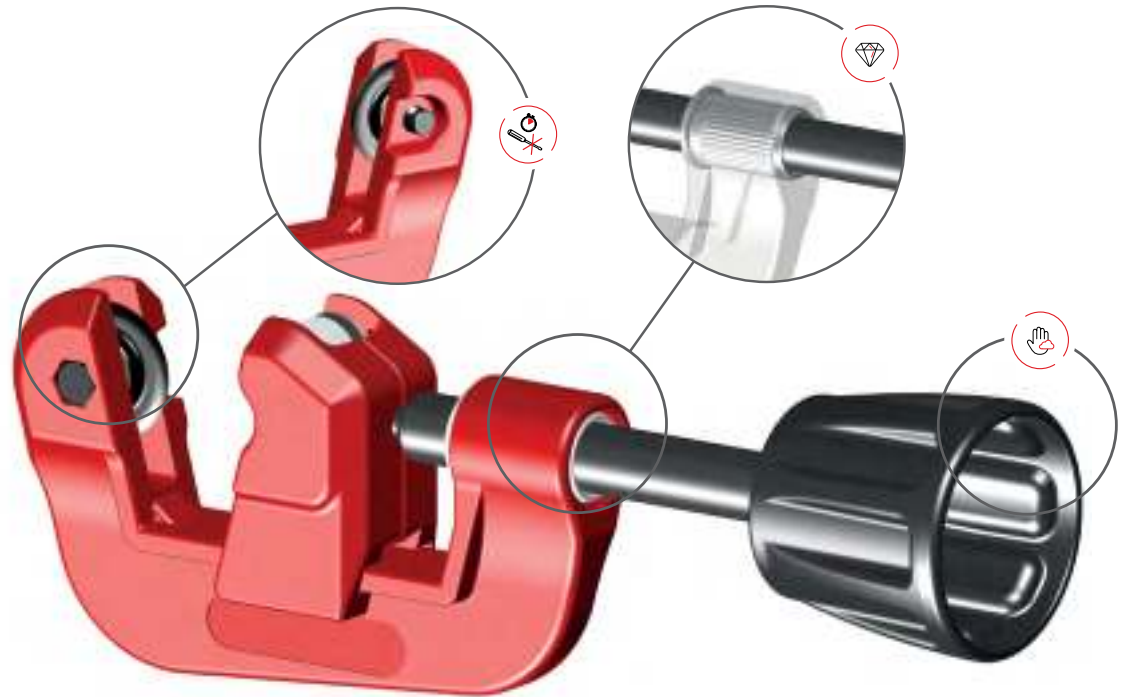

Registered Design



### Resistente / Resistent / Resistant / Résistant

- Desplazamiento del eje a través de casquillo de acero roscado.
- Stahlgelagerte Spindel.
- Threading of feed screw on steel socket.
- Déplacement de l'axe à travers une frette en acier.



### Instantáneo / Sofortiger / Instant / Instantané

- Sistema ICS (Instant Change System). Cambio de cuchilla instantáneo sin necesidad de herramienta.
- ICS-System (Instant Change System). Schneidrädchen-Schnellwechsel ohne Werkzeug.
- ICS-System (Instant Change System). No tool required for instant wheel change.
- Système ICS (Instant Change System). Changement instantané de la molette sans besoin d'outil.



### Confort / Komfort / Comfort / Confort

- Pomo ergonómico.
- Ergonomischer Drehknopf.
- Ergonomic knob.
- Pommeau ergonomique.

Para tubos metálicos de pared delgada.

Für dünnwandige Metallrohre.

For thin metal tubes.

Pour tubes métalliques à paroi mince.

AL, CU & INOX (MAX. 2 mm)

REF.	Ø mm		DISPLAY			
7036-0	3-35	1x	385	----	10	40
7036-1	3-35	1x	395	●	5	50



6001-0  
19x5mm



6005-0  
19x6,20mm

7336-0	3-35	1x	385	----	10	40
7336-1	3-35	1x	395	●	5	50

AL, CU (MAX. 2 mm)

7036-2	3-35	1x	385	----	10	40
7036-3	3-35	1x	395	●	5	50



6008-0  
19x5mm

7336-2	3-35	1x	385	----	10	40
7336-3	3-35	1x	395	●	5	50



6009-0  
19x6,20mm



Registered Design



**Resistente / Resistent / Resistant / Résistant**

- Desplazamiento del eje a través de casquillo de acero roscado.
- Stahlgelagerte Spindel.
- Threading of feed screw on steel socket.
- Déplacement de l'axe à travers une frette en acier.



**Instantáneo / Sofortiger / Instant / Instantané**

- Sistema ICS (Instant Change System). Cambio de cuchilla instantáneo sin necesidad de herramienta.
- ICS-System (Instant Change System). Schneidrädchen-Schnellwechsel ohne Werkzeug.
- ICS-System (Instant Change System). No tool required for instant wheel change.
- Système ICS (Instant Change System). Changement instantané de la molette sans besoin d'outil.



**Confort / Komfort / Comfort / Confort**

- Pomo ergonómico.
- Ergonomischer Drehknopf.
- Ergonomic knob.
- Pommeau ergonomique.



**Solución / Lösung / Solution / Solution**

- Radio de trabajo extra reducido.
- Mit extrem reduziertem Arbeitsradius.
- Extra reduced radius spin.
- Rayon de travail extra réduit.

Para tubos metálicos de pared delgada.

Für dünnwandige Metallrohre.

For thin metal tubes.

Pour tubes métalliques à paroi mince.

AL, CU & INOX (MAX. 2 mm)

REF.	Ø mm			DISPLAY		
6230-0	3-30	2x	215	----	25	100
6230-1	3-30	2x	220	●	10	100

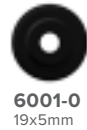

6430-0	3-30	2x	215	----	25	100
6430-1	3-30	2x	220	●	10	100



AL, CU (MAX. 2 mm)

6230-2	3-30	2x	215	----	25	100
6230-3	3-30	2x	220	●	10	100



6430-2	3-30	2x	215	----	25	100
6430-3	3-30	2x	220	●	10	100



Registered Design



**Resistente / Resistent / Resistant / Résistant**

- Desplazamiento del eje a través de casquillo de acero roscado.
- Stahlgelagerte Spindel.
- Threading of feed screw on steel socket.
- Déplacement de l'axe à travers une frette en acier.



**Instantáneo / Sofortiger / Instant / Instantané**

- Sistema ICS (Instant Change System). Cambio de cuchilla instantáneo sin necesidad de herramienta.
- ICS-System (Instant Change System). Schneidrädchen-Schnelwechsel ohne Werkzeug.
- ICS-System (Instant Change System). No tool required for instant wheel change.
- Système ICS (Instant Change System). Changement instantané de la molette sans besoin d'outil.



**Confort / Komfort / Comfort / Confort**

- Pomo ergonómico.
- Ergonomischer Drehknopf.
- Ergonomic knob.
- Pommeau ergonomique.



**Útil / Handlich / Handy / Utile**

- Cuchilla de recambio en el pomo.
- Ersatzrädchen im Drehknopf.
- Spare cutting wheel in knob.
- Molette de rechange dans le pommeau.

## MAGNESIUM

Para tubos metálicos de pared delgada.

Für dünnwandige Metallrohre.

For thin metal tubes.

Pour tubes métalliques à paroi mince.

### AL, CU & INOX (MAX. 2 mm)

REF.	Ø mm			DISPLAY		
------	------	--	--	---------	--	--

7135-0	3-35	2x	335	----	10	40
--------	------	----	-----	------	----	----

7135-1	3-35	2x	345	•	3	30
--------	------	----	-----	---	---	----

7435-0	3-35	2X	335	----	10	40
--------	------	----	-----	------	----	----

7435-1	3-35	2x	345	•	3	30
--------	------	----	-----	---	---	----

### AL, CU (MAX. 2 mm)

7135-2	3-35	2X	335	----	10	40
--------	------	----	-----	------	----	----

7135-3	3-35	2x	345	•	3	30
--------	------	----	-----	---	---	----

7435-2	3-35	2X	335	----	10	40
--------	------	----	-----	------	----	----

7435-3	3-35	2x	345	•	3	30
--------	------	----	-----	---	---	----



**6001-0**  
19x5mm



**6005-0**  
19x6,20mm



**6008-0**  
19x5mm



**6009-0**  
19x6,20mm

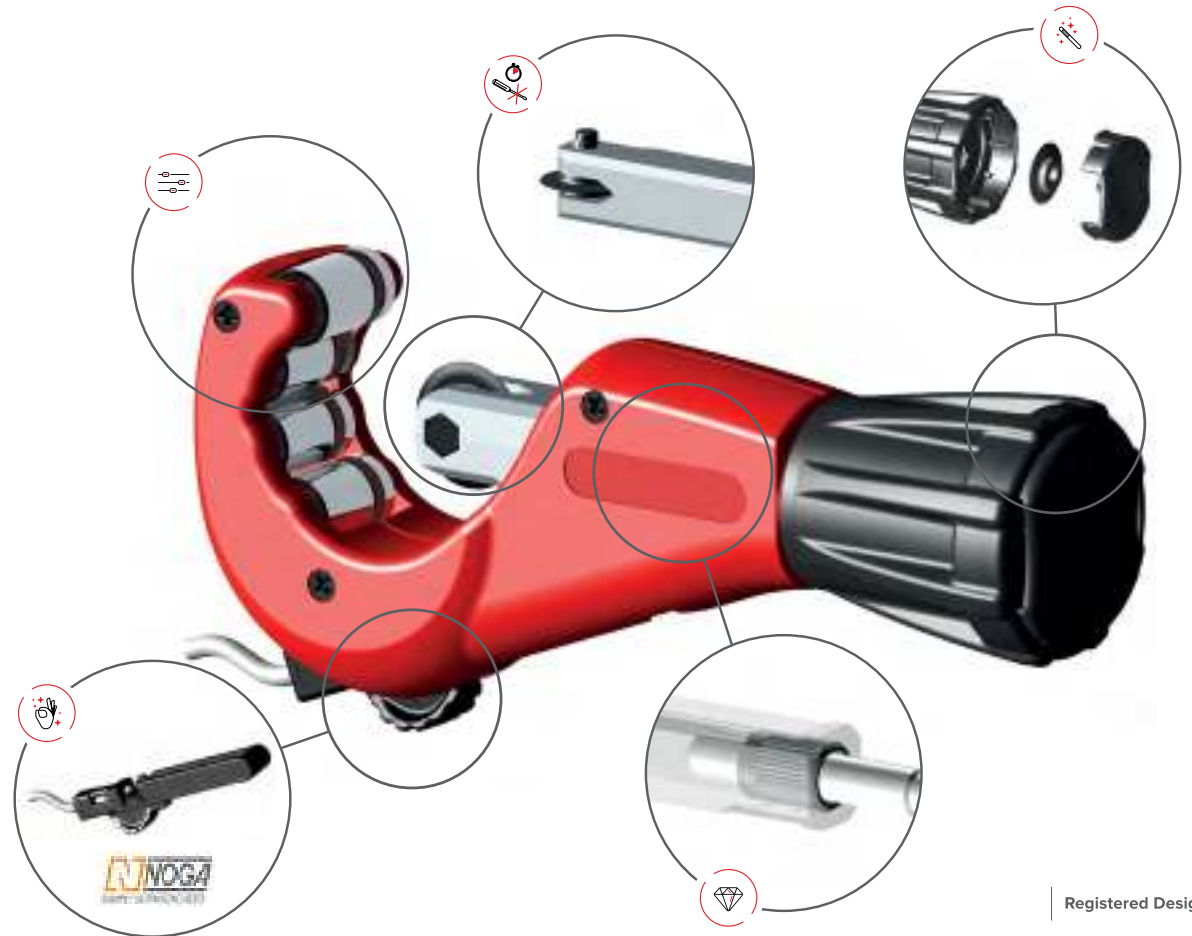

Registered Design



#### Resistente / Resistent / Resistant / Résistant

- Desplazamiento del eje a través de casquillo de acero roscado.
- Stahlgelagerte Spindel.
- Threading of feed screw on steel socket.
- Déplacement de l'axe à travers une frette en acier.



#### Instantáneo / Sofortiger / Instant / Instantané

- Sistema ICS (Instant Change System). Cambio de cuchilla instantáneo sin necesidad de herramienta.
- ICS-System (Instant Change System). Schneidrädchen-Schnellwechsel ohne Werkzeug.
- ICS-System (Instant Change System). No tool required for instant wheel change.
- Système ICS (Instant Change System). Changement instantané de la molette sans besoin d'outil.



#### Estable / Stabil / Stable / Stable

- 4 rodillos para un mejor agarre del tubo.
- 4 Führungsrollen für einen optimalen Halt des Rohres.
- 4 rollers for a better fastening of the tube.
- 4 rouleaux pour un meilleur accrochage du tube.



#### Práctico / Praktisch / Practical / Pratique

- Rebabador NOGA completamente extraíble.
- NOGA Entgrater-Klinge. Kann komplett herausgezogen werden.
- Complete removable NOGA professional reamer.
- Ébavureur NOGA complètement extractible.



#### Útil / Handlich / Handy / Utile

- Cuchilla de recambio en la tapa del pomo.
- Ersatzrädchen in Drehknopf-Kappe.
- Spare cutting wheel on the cap of the knob.
- Molette de rechange dans le bouchon du pommeau.

## MAGNESIUM

**Para tubos metálicos de pared delgada.**  
**Für dünnwandige Metallrohre.**  
**For thin metal tubes.**  
**Pour tubes métalliques à paroi mince.**

### AL, CU & INOX (MAX. 2 mm)

REF.	Ø mm		90°	DISPLAY		
7145-0	3-45	2x	355	-----	5	50
7145-1	3-45	2x	365	•	3	30



**6001-0**  
19x5mm



**6005-0**  
19x6,20mm

### AL, CU (MAX. 2 mm)

7145-2	3-45	2X	355	-----	5	50
7145-3	3-45	2x	365	•	3	30



**6008-0**  
19x5mm

7445-2	3-45	2X	355	-----	5	50
7445-3	3-45	2x	365	•	3	30



**6009-0**  
19x6,20mm

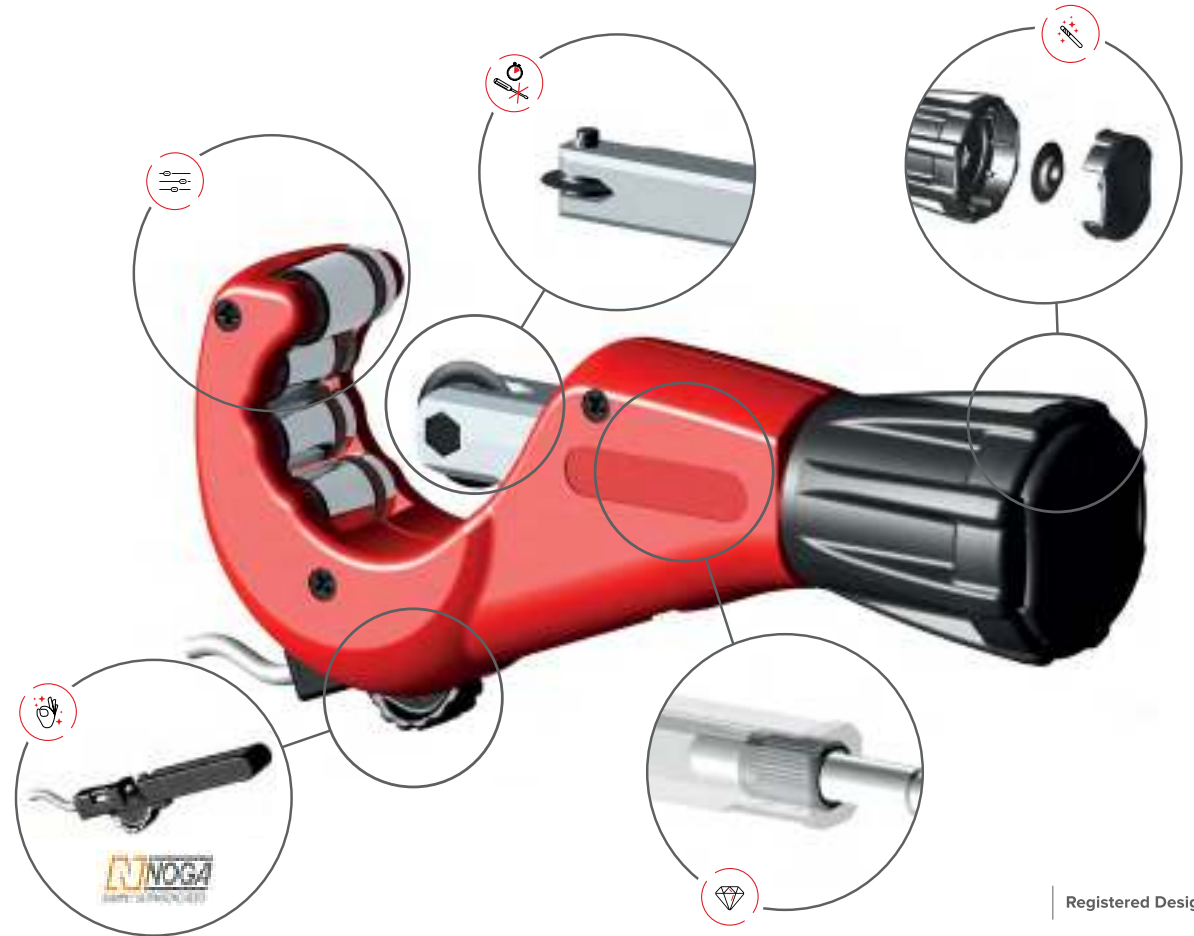

Registered Design



### Resistente / Resistent / Resistant / Résistant

- Desplazamiento del eje a través de casquillo de acero roscado.
- Stahlgelagerte Spindel.
- Threading of feed screw on steel socket.
- Déplacement de l'axe à travers une frette en acier.



### Estable / Stabil / Stable / Stable

- 4 rodillos para un mejor agarre del tubo.
- 4 Führungsrollen für einen optimalen Halt des Rohres.
- 4 rollers for a better fastening of the tube.
- 4 rouleaux pour un meilleur accrochage du tube.



### Útil / Handlich / Handy / Utile

- Cuchilla de recambio en la tapa del pomo.
- Ersatzrädchen in Drehknopf-Kappe.
- Spare cutting wheel on the cap of the knob.
- Molette de rechange dans le bouchon du pommeau.



### Instantáneo / Sofortiger / Instant / Instantané

- Sistema ICS (Instant Change System). Cambio de cuchilla instantáneo sin necesidad de herramienta.
- ICS-System (Instant Change System). Schneidrädchen-Schnellwechsel ohne Werkzeug.
- ICS-System (Instant Change System). No tool required for instant wheel change.
- Système ICS (Instant Change System). Changement instantané de la molette sans besoin d'outil.



### Práctico / Praktisch / Practical / Pratique

- Rebabador NOGA completamente extraíble.
- NOGA Entgrater-Klinge. Kann komplett herausgezogen werden.
- Complete removable NOGA professional reamer.
- Ébavureur NOGA complètement extractible.

# kompakt+ quick

MODEL 7476  
Ø 1/4"-3" (6-76mm)

Para tubos metálicos de pared delgada.

Für dünnwandige Metallrohre.

For thin metal tubes.

Pour tubes métalliques à paroi mince.

AL, CU & INOX (MAX. 2 mm)

REF.	Ø mm		g	DISPLAY		
7476-0	6-76	2x	880	----	1	15
7476-1	6-76	2x	905	●	0	12



AL, CU (MAX. 2 mm)

7476-2	6-76	2x	880	----	1	15
7476-3	6-76	2x	905	●	0	12

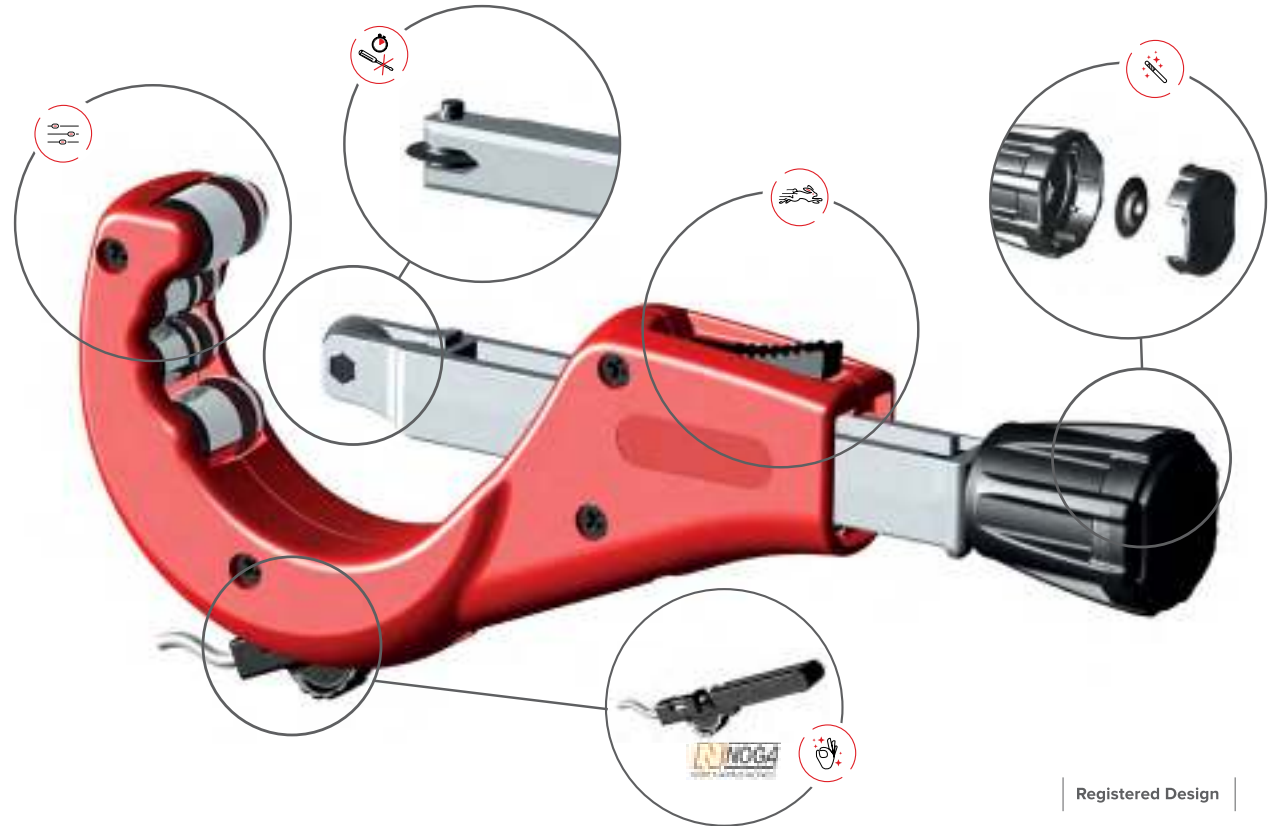

Registered Design

## Rápido / Schnell / Quick / Rapide

- Sistema de avance rápido.
- Schnell-Vorschub System.
- Quick-release system.
- Système d'avance rapide.

## Instantáneo / Sofortiger / Instant / Instantané

- Sistema ICS (Instant Change System). Cambio de cuchilla instantáneo sin necesidad de herramienta.
- ICS-System (Instant Change System). Schneidrädchen-Schnellwechsel ohne Werkzeug.
- ICS-System (Instant Change System). No tool required for instant wheel change.
- Système ICS (Instant Change System). Changement instantané de la molette sans besoin d'outil.

## Estable / Stabil / Stable / Stable

- 4 rodillos para un mejor agarre del tubo.
- 4 Führungsrollen für einen optimalen Halt des Rohres.
- 4 rollers for a better fastening of the tube.
- 4 rouleaux pour un meilleur accrochage du tube.

## Práctico / Praktisch / Practical / Pratique

- Rebabador NOGA completamente extraíble.
- NOGA Entgrater-Klinge. Kann komplett herausgezogen werden.
- Complete removable NOGA professional reamer.
- Ébavureur NOGA complètement extractible.

## Útil / Handlich / Handy / Utile

- Cuchilla de recambio en la tapa del pomo.
- Ersatzrädchen in Drehknopf-Kappe.
- Spare cutting wheel on the cap of the knob.
- Molette de rechange dans le bouchon du pommeau.







Para tubos metálicos de pared delgada.

Für dünnwandige Metallrohre.

For thin metal tubes.

Pour tubes métalliques à paroi mince.

Registered Design

REF.	Ø mm				
7477-0	50-127	1x	1620	1	6
7477-1	50-127	1x	1620	1	6

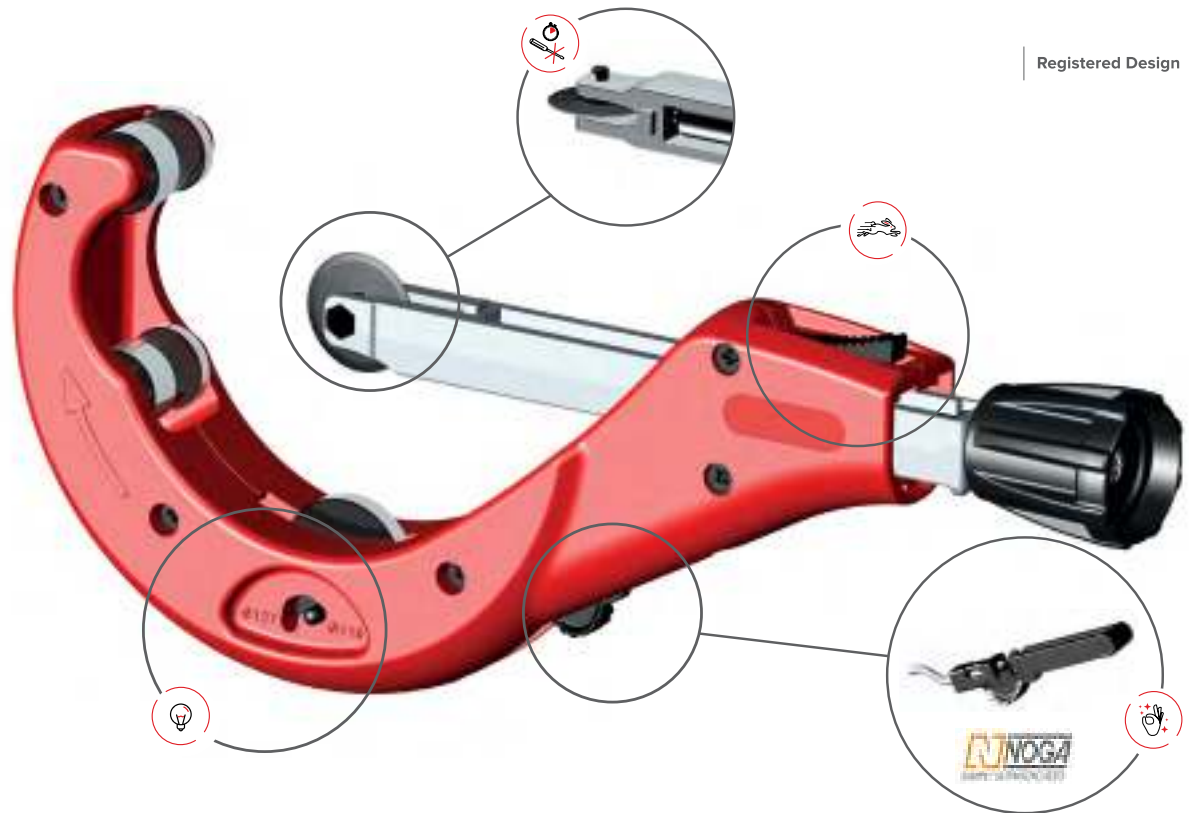

#### Solución / Lösung / Solution / Solution

- Tercer rodillo regulable en dos posiciones (110mm y 127mm). Mejor guiado del tubo durante el corte.
- Posición 110mm: para cortar tubos hasta 110mm.
- Posición 127mm: para cortar tubos a partir de 110mm hasta 127mm.

• In zwei Positionen (110mm und 127mm) verstellbare dritte Führungsrolle für eine optimale Führung des Rohres beim Schneiden.

- Position 110mm: Zum Schneiden von Rohren bis inklusive 110mm.
- Position 127mm: Zum Schneiden von Rohren ab 110mm und bis 127mm.

• Adjustable third roller in 2 positions (110mm and 127mm) for a better guiding of the tube while cutting.

- 110mm position: to cut tubes up to 110mm.
- 127mm position: to cut tubes from 110mm up to 127mm.

• Troisième rouleau réglable en 2 positions (110mm et 127mm) pour un meilleur guidage du tube lors de la coupe.

- Position 110mm: pour couper des tubes jusqu'à 110mm.
- Position 127mm: pour couper des tubes à partir de 110mm jusqu'à 127mm.



#### Rápido / Schnell / Quick / Rapide

- Sistema de avance rápido.
- Schnell-Vorschub System.
- Quick-release system.
- Système d'avance rapide.



#### Instantáneo / Sofortiger / Instant / Instantané

- Sistema ICS (Instant Change System). Cambio de cuchilla instantáneo sin necesidad de herramienta.
- ICS-System (Instant Change System). Schneidrädchen-Schnellwechsel ohne Werkzeug.
- ICS-System (Instant Change System). No tool required for instant wheel change.
- Système ICS (Instant Change System). Changement instantané de la molette sans besoin d'outil.



#### Práctico / Praktisch / Practical / Pratique

- Rebabador NOGA completamente extraíble.
- NOGA Entgrater-Klinge. Kann komplett herausgezogen werden.
- Complete removable NOGA professional reamer.
- Ébavureur NOGA complètement extractible.

Para tubos metálicos de pared delgada.

Für dünnwandige Metallrohre.

For thin metal tubes.

Pour tubes métalliques à paroi mince.

Registered Design

REF.	Ø mm		g		
7478-0	100-170	1x	1830	1	6
7478-1	100-170	1x	1830	1	6

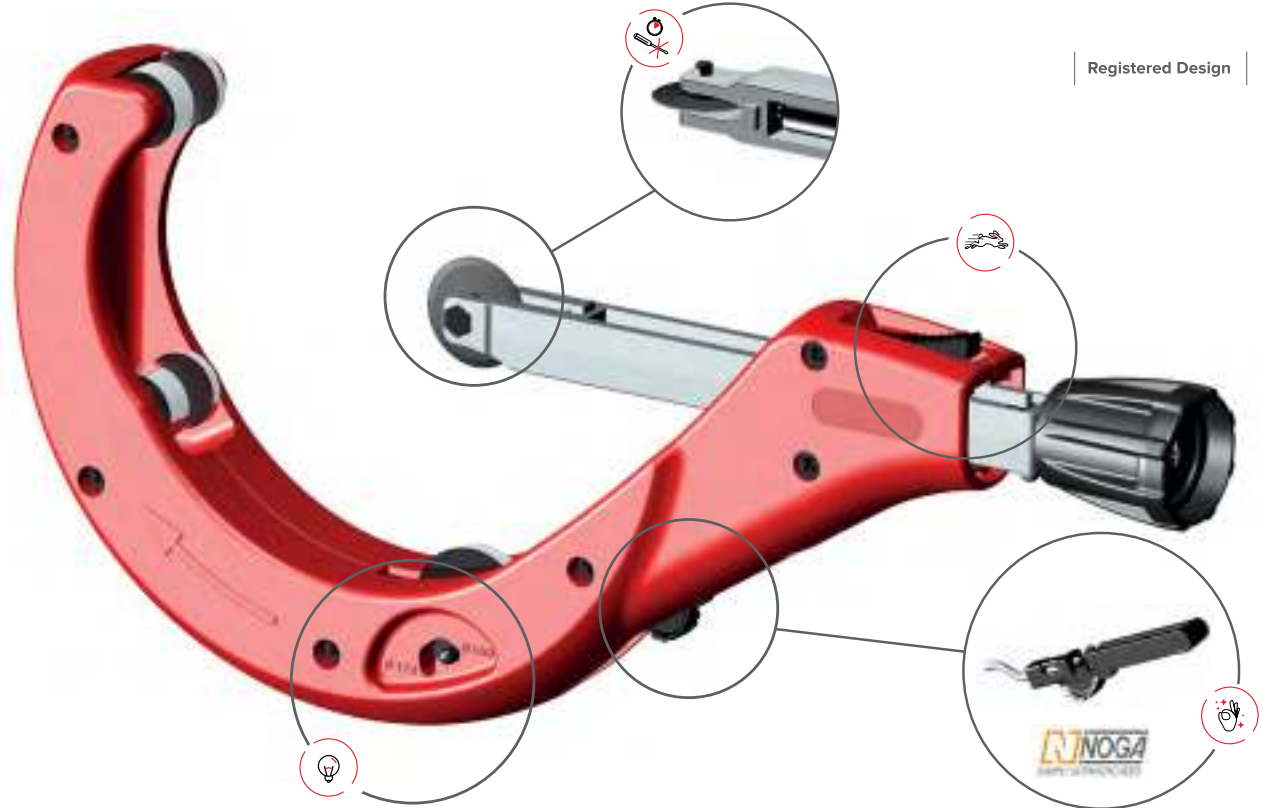

#### Solución / Lösung / Solution / Solution

- Tercer rodillo regulable en dos posiciones (160mm y 170mm). Mejor guiado del tubo durante el corte.
- Posición 160mm: para cortar tubos hasta 160mm.
- Posición 170mm: para cortar tubos a partir de 160mm hasta 170mm

• In zwei Positionen (160mm und 170mm) verstellbare dritte Führungsrolle für eine optimale Führung des Rohres beim Schneiden.

- Position 160mm: Zum Schneiden von Rohren bis inklusive 160mm.
- Position 170mm: Zum Schneiden von Rohren ab 160mm und bis 170mm.

• Adjustable third roller in 2 positions (160mm and 170mm) for a better guiding of the tube while cutting.

- 160mm position: to cut tubes up to 160mm.
- 170mm position: to cut tubes from 160mm up to 170mm.

• Troisième rouleau réglable en 2 positions (160mm et 170mm) pour un meilleur guidage du tube lors de la coupe.

- Position 160mm: pour couper des tubes jusqu'à 160mm.
- Position 170mm: pour couper des tubes a partir de 160mm jusqu'à 170mm



#### Rápido / Schnell / Quick / Rapide

- Sistema de avance rápido.
- Schnell-Vorschub System.
- Quick-release system.
- Système d'avance rapide.



#### Instantáneo / Sofortiger / Instant / Instantané

- Sistema ICS (Instant Change System). Cambio de cuchilla instantáneo sin necesidad de herramienta.
- ICS-System (Instant Change System). Schneidrädchen-Schnellwechsel ohne Werkzeug.
- ICS-System (Instant Change System). No tool required for instant wheel change.
- Système ICS (Instant Change System). Changement instantané de la molette sans besoin d'outil.



#### Práctico / Praktisch / Practical / Pratique

- Rebabador NOGA completamente extraíble.
- NOGA Entgrater-Klinge. Kann komplett herausgezogen werden.
- Complete removable NOGA professional reamer.
- Ébavureur NOGA complètement extractible.

ZENTEN



# 06

---

**Para tubos de inox**  
**Für Inox Rohre**  
**For inox tubes**  
**Pour tubes en inox**

---

ZENTEN

Para tubos de inox

Für Inox Rohre

For inox tubes

Pour tubes en inox

REF.	Ø mm		gr.	DISPLAY	
7230-0	3-30	2x	215	----	25 100
7230-1	3-30	2x	220	•	10 100
7530-0	3-30	2x	215	----	25 100
7530-1	3-30	2x	220	•	10 100



**6001-8**  
19x5mm



**6005-8**  
19x6,2mm

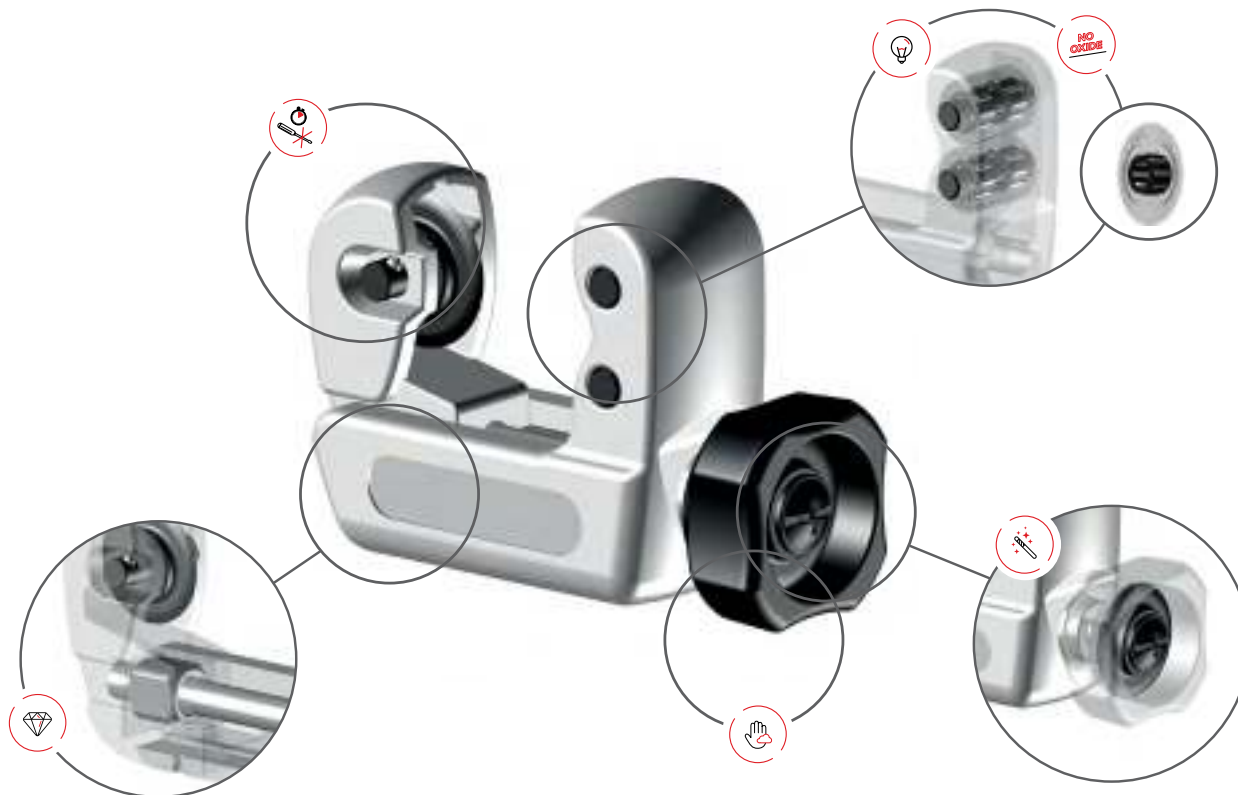

Registered Design



### Resistente / Resistent / Resistant / Résistant

- Desplazamiento del eje a través de casquillo de acero roscado.
- Stahlgelagerte Spindel.
- Threading of feed screw on steel socket.
- Déplacement de l'axe à travers une frette en acier.



### Instantáneo / Sofortiger / Instant / Instantané

- Sistema ICS (Instant Change System). Cambio de cuchilla instantáneo sin necesidad de herramienta.
- ICS-System (Instant Change System). Schneidrädchen-Schnellwechsel ohne Werkzeug.
- ICS-System (Instant Change System). No tool required for instant wheel change.
- Système ICS (Instant Change System). Changement instantané de la molette sans besoin d'outil.



### Solución / Lösung / Solution / Solution

- Rodillos y cuchilla con corona de agujas.
- Nadelgelagerte Führungsrollen und Schneidrädchen.
- Rollers and cutting wheel with needle bearings.
- Rouleaux et molette avec cages à aiguilles.



### No óxido / Kein Oxid / No oxide / Non oxyde

- Rodillos INOX.
- Führungsrollen aus INOX-Stahl.
- INOX rollers.
- Rouleaux INOX.



### Comfort / Komfort / Comfort / Confort

- Pomo ergonómico.
- Ergonomischer Drehknopf.
- Ergonomic knob.
- Pommeau ergonomique.



### Útil / Handlich / Handy / Utile

- Cuchilla de recambio en el pomo.
- Ersatzrädchen im Drehknopf.
- Spare cutting wheel in knob.
- Molette de rechange dans le pommeau.

## MAGNESIUM

Para tubos de inox

Für Inox Rohre

For inox tubes

Pour tubes en inox

REF.    Ø mm            DISPLAY        

7235-0 3-35 2x 335 ----- 10 40

7235-1 3-35 2x 345 • 3 30

7535-0 3-35 2X 335 ----- 10 40

7535-1 3-35 2x 345 • 3 30



**6001-8**  
19x5mm



**6005-8**  
19x6,20mm

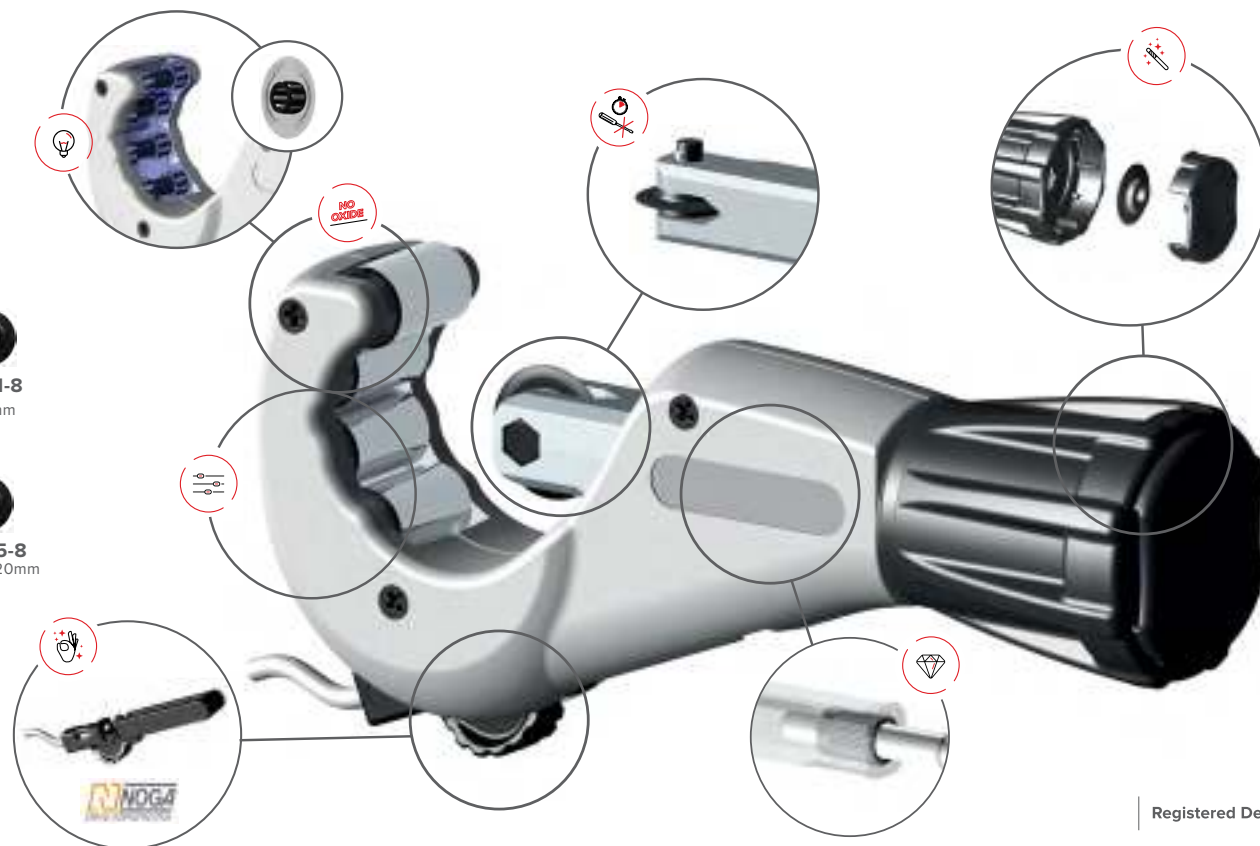

Registered Design



### Resistente / Resistent / Resistant / Résistant

- Desplazamiento del eje a través de casquillo de acero roscado.
- Stahlgelagerte Spindel.
- Threading of feed screw on steel socket.
- Déplacement de l'axe à travers une frette en acier.



### Instantáneo / Sofortiger / Instant / Instantané

- Sistema ICS (Instant Change System). Cambio de cuchilla instantáneo sin necesidad de herramienta.
- ICS-System (Instant Change System). Schneidradchen-Schnellwechsel ohne Werkzeug.
- ICS-System (Instant Change System). No tool required for instant wheel change.
- Système ICS (Instant Change System). Changement instantané de la molette sans besoin d'outil.



### Solución / Lösung / Solution / Solution

- Rodillos y cuchilla con corona de agujas.
- Nadelgelagerte Führungsrollen und Schneidradchen.
- Rollers and cutting wheel with needle bearings.
- Rouleaux et molette avec cages à aiguilles.



### Estable / Stabil / Stable / Stable

- 4 rodillos para un mejor agarre del tubo.
- 4 Führungsrollen für einen optimalen Halt des Rohres.
- 4 rollers for a better fastening of the tube.
- 4 rouleaux pour un meilleur accrochage du tube.



### No óxido / Kein Oxid / No oxide / Non oxyde

- Rodillos INOX.
- Führungsrollen aus INOX-Stahl.
- INOX rollers.
- Rouleaux INOX.



### Práctico / Praktisch / Practical / Pratique

- Rebabador NOGA completamente extraíble.
- NOGA Entgrater-Klinge. Kann komplett herausgezogen werden.
- Complete removable NOGA professional reamer.
- Ébavureur NOGA complètement extractible.



### Útil / Handlich / Handy / Utile

- Cuchilla de recambio en la tapa del pomo.
- Ersatzradchen in Drehknopf-Kappe.
- Spare cutting wheel on the cap of the knob.
- Molette de rechange dans le bouchon du pomeau.

## MAGNESIUM

Para tubos de inox

Für Inox Rohre

For inox tubes

Pour tubes en inox

REF.	Ø mm		gr.	DISPLAY		
------	------	--	-----	---------	--	--

7245-0	3-45	2x	355	----	5	50
--------	------	----	-----	------	---	----

7245-1	3-45	2x	365	•	3	30
--------	------	----	-----	---	---	----

7545-0	3-45	2X	355	----	5	50
--------	------	----	-----	------	---	----

7545-1	3-45	2x	365	•	3	30
--------	------	----	-----	---	---	----

**6001-8**  
19x5mm

**6005-8**  
19x6,20mm

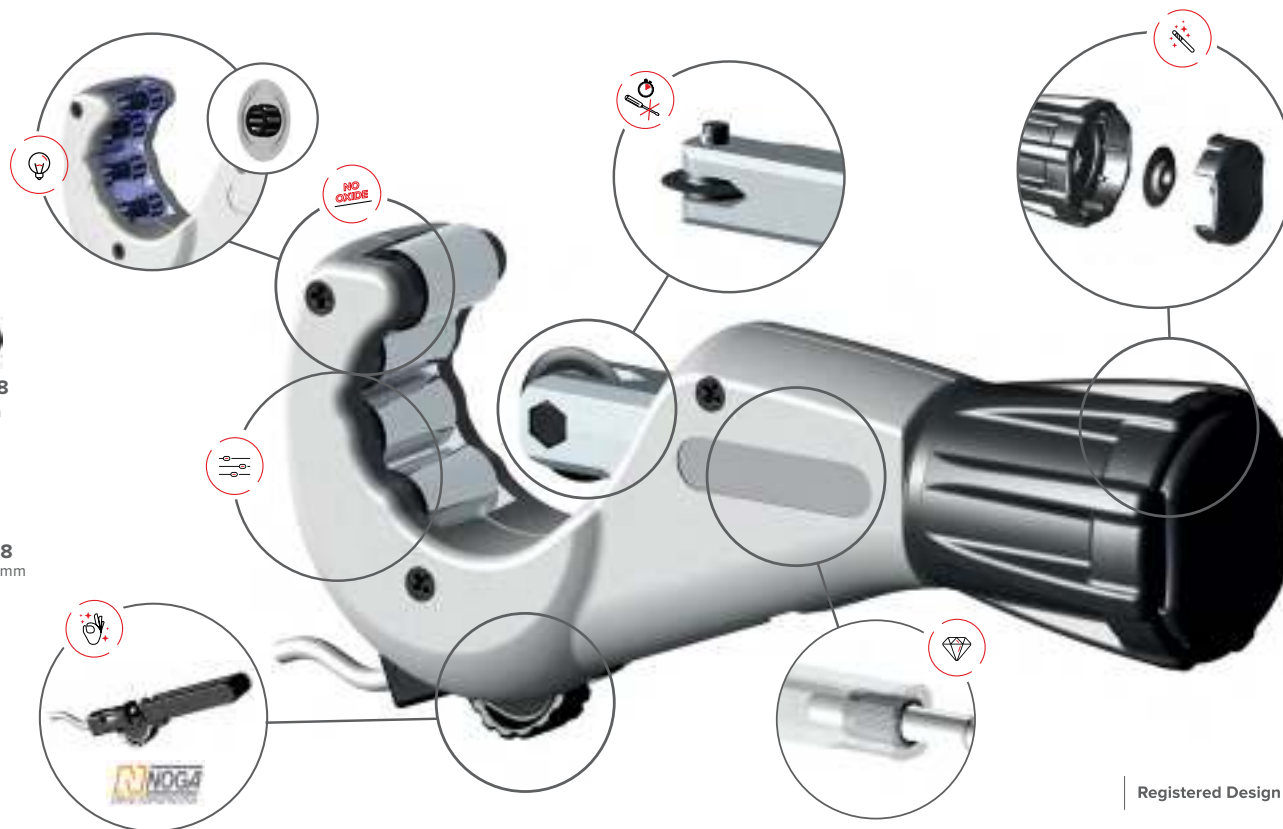

Registered Design

### Resistente / Resistent / Resistant / Résistant

- Desplazamiento del eje a través de casquillo de acero roscado.
- Stahlgelagerte Spindel.
- Threading of feed screw on steel socket.
- Déplacement de l'axe à travers une frette en acier.

### Instantáneo / Sofortiger / Instant / Instantané

- Sistema ICS (Instant Change System). Cambio de cuchilla instantáneo sin necesidad de herramienta.
- ICS-System (Instant Change System). Schneidrädchen-Schnellwechsel ohne Werkzeug.
- ICS-System (Instant Change System). No tool required for instant wheel change.
- Système ICS (Instant Change System). Changement instantané de la molette sans besoin d'outil.

### Solución / Lösung / Solution / Solution

- Rodillos y cuchilla con corona de agujas.
- Nadelgelagerte Führungsrollen und Schneidrädchen.
- Rollers and cutting wheel with needle bearings.
- Rouleaux et molette avec cages à aiguilles.

### Estable / Stabil / Stable / Stable

- 4 rodillos para un mejor agarre del tubo.
- 4 Führungsrollen für einen optimalen Halt des Rohres.
- 4 rollers for a better fastening of the tube.
- 4 rouleaux pour un meilleur accrochage du tube.

### No óxido / Kein Oxid / No oxide / Non oxyde

- Rodillos INOX.
- Führungsrollen aus INOX-Stahl.
- INOX rollers.
- Rouleaux INOX.

### Práctico / Praktisch / Practical / Pratique

- Rebabador NOGA completamente extraíble.
- NOGA Entgrater-Klinge. Kann komplett herausgezogen werden.
- Complete removable NOGA professional reamer.
- Ébavureur NOGA complètement extractible.

### Útil / Handlich / Handy / Utile

- Cuchilla de recambio en la tapa del pomo.
- Ersatzrädchen in Drehknopf-Kappe.
- Spare cutting wheel on the cap of the knob.
- Molette de rechange dans le bouchon du pomeau.



Para tubos de inox

Für Inox Rohre

For inox tubes

Pour tubes en inox

REF.	Ø mm		gr.	DISPLAY		
7576-0	6-76	2x	880	----	1	15
7576-1	6-76	2x	905	•	0	12

**6005-8**  
19x6,2mm

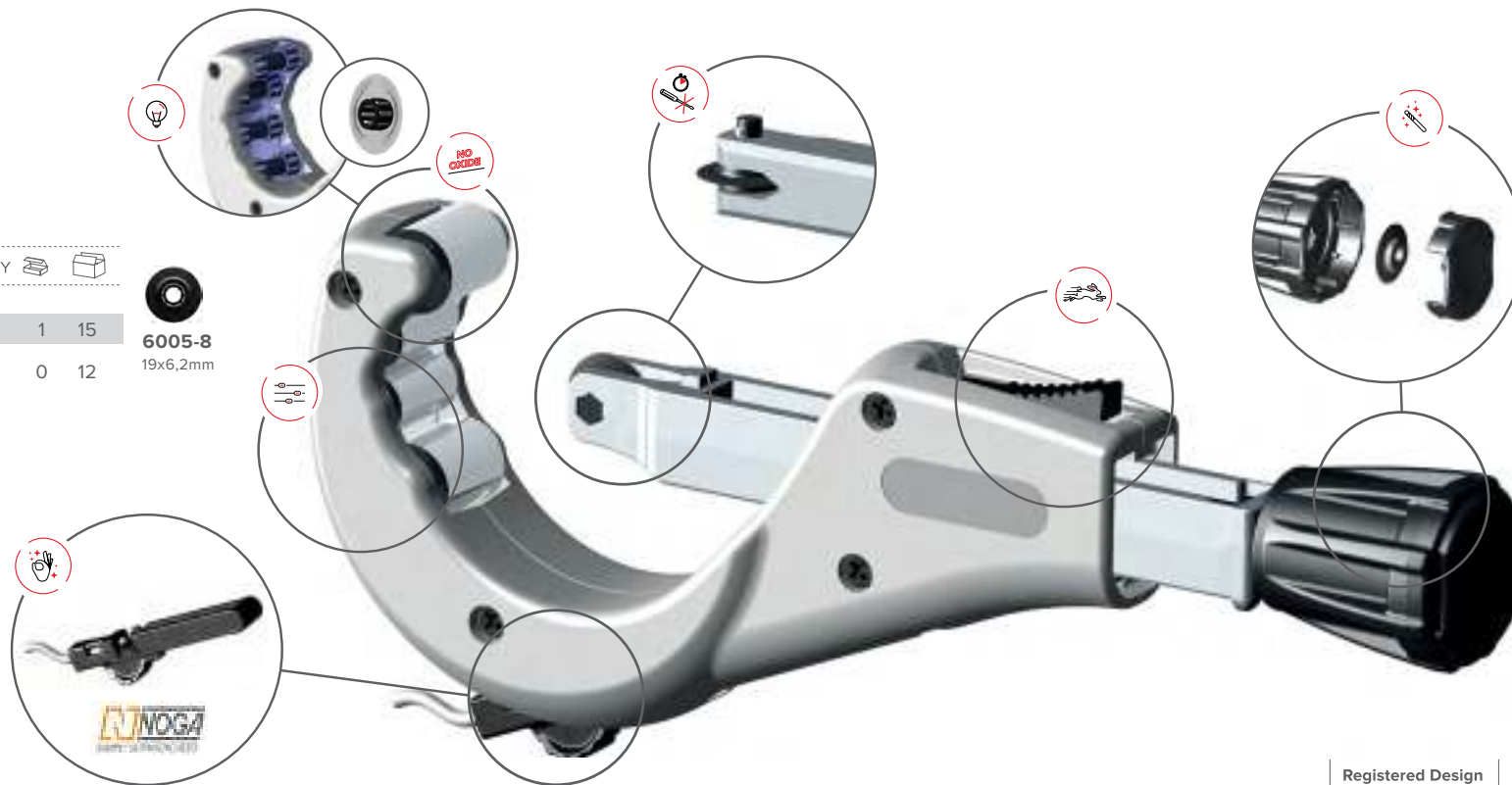

Registered Design

#### Rápido / Schnell / Quick / Rapide

- Sistema de avance rápido.
- Schnell-Vorschub System.
- Quick-release system.
- Système d'avance rapide.

#### Instantáneo / Sofortiger / Instant / Instantané

- Sistema ICS (Instant Change System). Cambio de cuchilla instantáneo sin necesidad de herramienta.
- ICS-System (Instant Change System). Schneidrädchen-Schnellwechsel ohne Werkzeug.
- ICS-System (Instant Change System). No tool required for instant wheel change.
- Système ICS (Instant Change System). Changement instantané de la molette sans besoin d'outil.

#### Solución / Lösung / Solution / Solution

- Rodillos y cuchilla con corona de agujas.
- Nadelgelagerte Führungsrollen und Schneidrädchen.
- Rollers and cutting wheel with needle bearings.
- Rouleaux et molette avec cages à aiguilles.

#### Estable / Stabil / Stable / Stable

- 4 rodillos para un mejor agarre del tubo.
- 4 Führungsrollen für einen optimalen Halt des Rohres.
- 4 rollers for a better fastening of the tube.
- 4 rouleaux pour un meilleur accrochage du tube.

#### No óxido / Kein Oxid / No oxide / Non oxyde

- Rodillos INOX.
- Führungsrollen aus INOX-Stahl.
- INOX rollers.
- Rouleaux INOX.

#### Práctico / Praktisch / Practical / Pratique

- Rebadador NOGA completamente extraíble.
- NOGA Entgrater-Klinge. Kann komplett herausgezogen werden.
- Complete removable NOGA professional reamer.
- Ébavureur NOGA complètement extractible.

#### Útil / Handlich / Handy / Utile

- Cuchilla de recambio en la tapa del pomo.
- Ersatzrädchen in Drehknopf-Kappe.
- Spare cutting wheel on the cap of the knob.
- Molette de rechange dans le bouchon du pommeau.



# 07

---

**Para tubos de acero e inox**  
**Für Stahl- und Inox Rohre**  
**For steel and inox tubes**  
**Pour tubes en acier et inox**

---

**ZENTEN**



Para tubos de acero e inox

Für Stahl- und Inox Rohre

For steel and inox tubes

Pour tubes en acier et inox

REF.	Ø mm				
6042-1	10-42	1	1200	1	8

**6014-0**  
25x14mm



Registered Design



**Resistente / Resistent / Resistant / Résistant**

- Cuerpo de acero forjado.
- Stahlgeschmiedeter Körper.
- Drop forged steel frame.
- Corps en acier forgé.



**Solución / Lösung / Solution / Solution**



- Sistema de muelle por arandelas para mejor corte y durabilidad de la cuchilla.
- Feder-Andrucksystem: Garantiert verbesserten Schnitt und längere Gebrauchsdauer des Schneidrädchens.
- Spring System by washers for a better cut and a longer lasting of cutting wheels.
- Système de ressort par rondelles pour une meilleure coupe et une plus grande durée des molettes.



**Instantáneo / Sofortiger / Instant / Instantané**

- Sistema ICS (Instant Change System). Cambio de cuchilla instantáneo sin necesidad de herramienta.
- ICS-System (Instant Change System). Schneidrädchen-Schnellwechsel ohne Werkzeug.
- ICS-System (Instant Change System). No tool required for instant wheel change.
- Système ICS (Instant Change System). Changement instantané de la molette sans besoin d'outil.

Para tubos de acero e inox  
**Für Stahl- und Inox Rohre**  
 For steel and inox tubes  
**Pour tubes en acier et inox**

REF.	Ø mm				
6050-1	10-60	1	2250	1	6

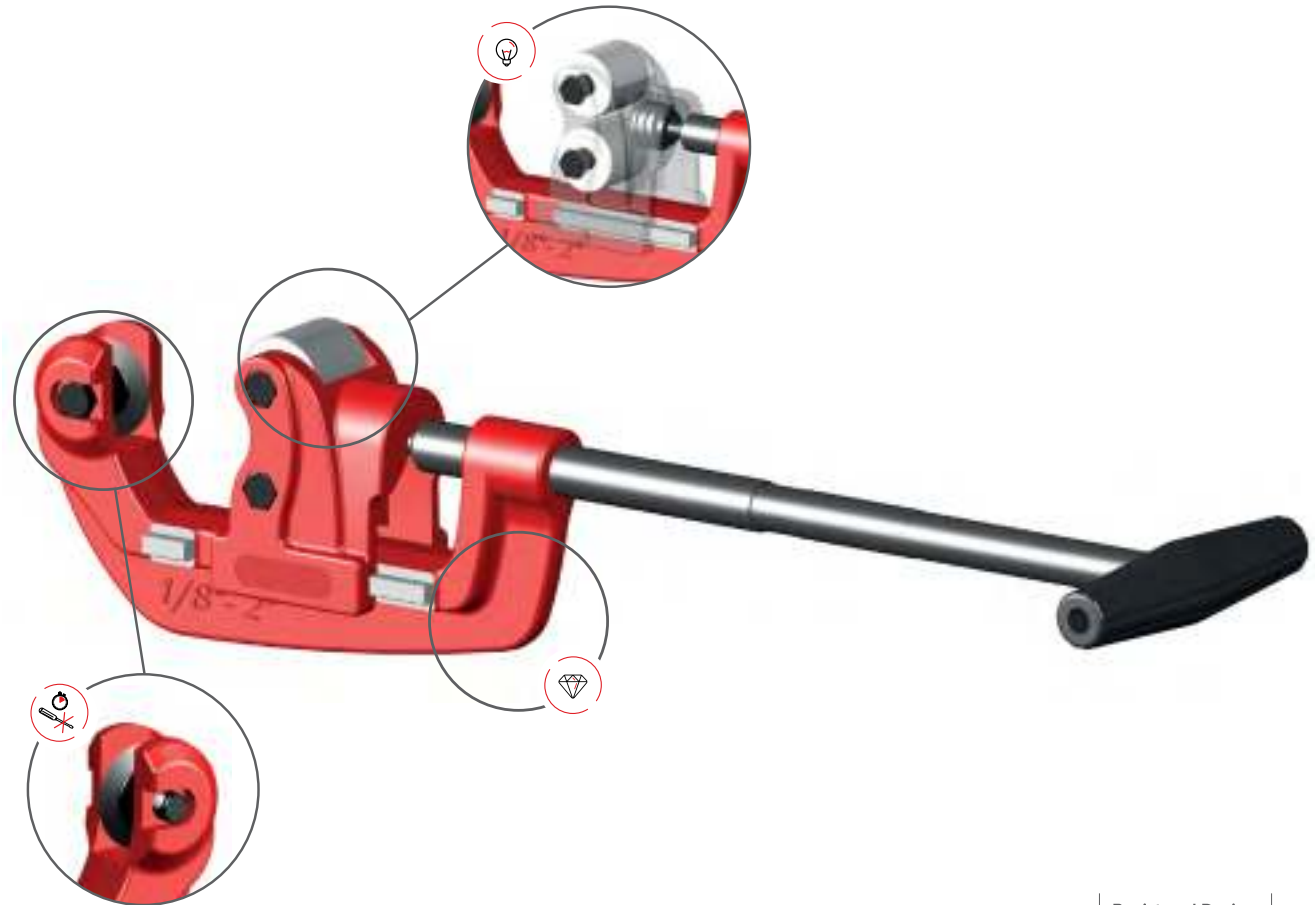
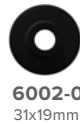

Registered Design



**Resistente / Resistent / Resistant / Résistant**

- Cuerpo de acero forjado.
- Stahlgeschmiedeter Körper.
- Drop forged steel frame.
- Corps en acier forgé.



**Solución / Lösung / Solution / Solution**

- Sistema de muelle por arandelas para mejor corte y durabilidad de la cuchilla.
- Feder-Andrucksystem: Garantiert verbesserten Schnitt und längere Gebrauchsdauer des Schneidrädchens.
- Spring System by washers for a better cut and a longer lasting of cutting wheels.
- Système de ressort par rondelles pour une meilleure coupe et une plus grande durée des molettes.



**Instantáneo / Sofortiger / Instant / Instantané**

- Sistema ICS (Instant Change System). Cambio de cuchilla instantáneo sin necesidad de herramienta.
- ICS-System (Instant Change System). Schneidrädchen-Schnellwechsel ohne Werkzeug.
- ICS-System (Instant Change System). No tool required for instant wheel change.
- Système ICS (Instant Change System). Changement instantané de la molette sans besoin d'outil.

Para tubos de acero e inox

Für Stahl- und Inox Rohre

For steel and inox tubes

Pour tubes en acier et inox

REF.	Ø mm				
6054-1	60-114	1	7600	1	4

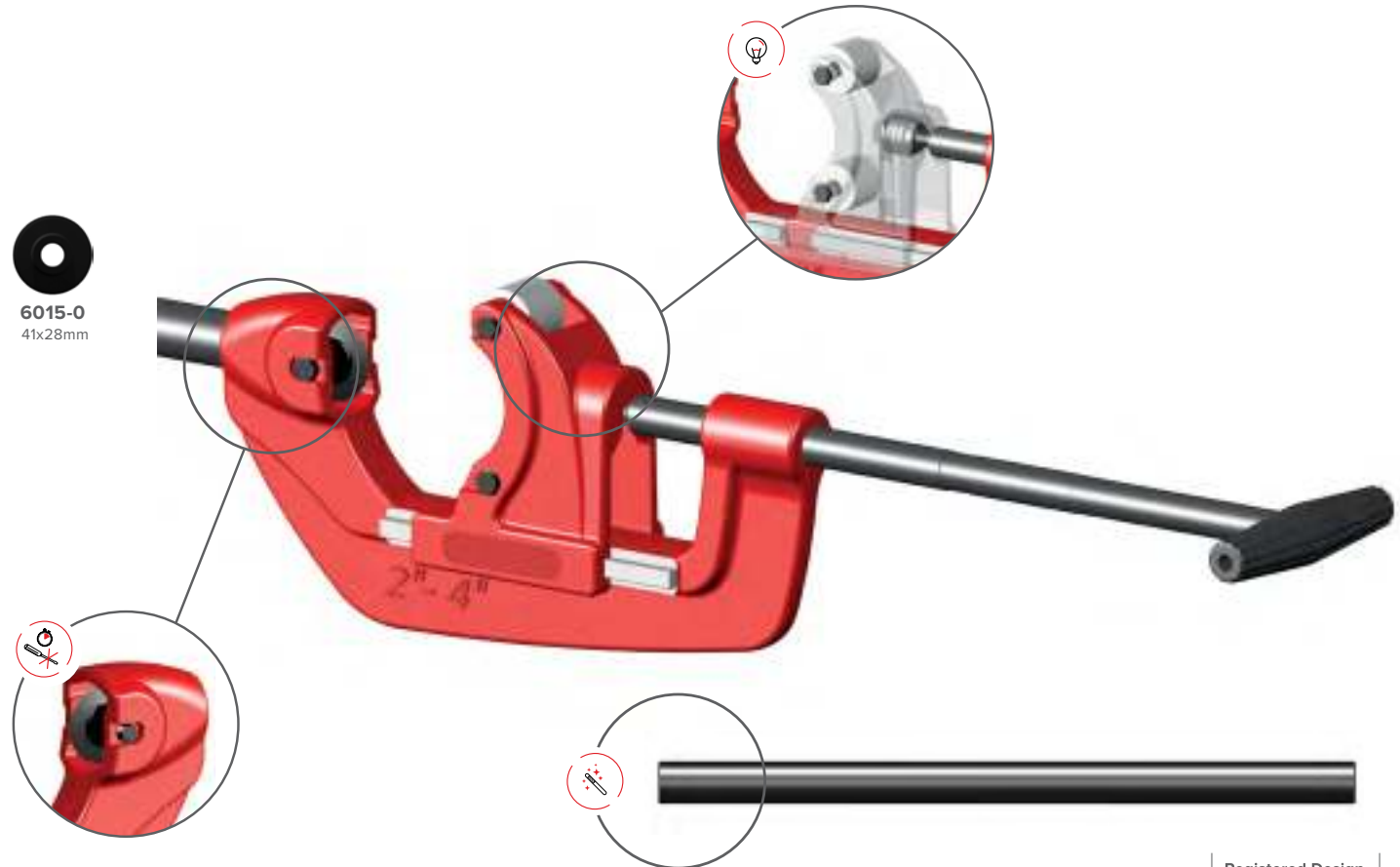
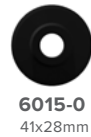

Registered Design



**Solución / Lösung / Solution / Solution**

- Sistema de muelle por arandelas para mejor corte y durabilidad de la cuchilla.
- Feder-Andrucksystem: Garantiert verbesserten Schnitt und längere Gebrauchsdauer des Schneidrädchens.
- Spring System by washers for a better cut and a longer lasting of cutting wheels.
- Système de ressort par rondelles pour une meilleure coupe et une plus grande durée des molettes.



**Instantáneo / Sofortiger / Instant / Instantané**

- Sistema ICS (Instant Change System). Cambio de cuchilla instantáneo sin necesidad de herramienta.
- ICS-System (Instant Change System). Schneidrädchen-Schnellwechsel ohne Werkzeug.
- ICS-System (Instant Change System). No tool required for instant wheel change.
- Système ICS (Instant Change System). Changement instantané de la molette sans besoin d'outil.



**Útil / Handlich / Handy / Utile**

- Con barra de ayuda auxiliar.
- Mit Zusatzhilfshebel.
- With tommy bar.
- Avec barre d'aide auxiliaire.

---

ZENTEN





**08**

---

**Cuchillas de recambio**  
**Ersatzrädchen**  
**Cutting wheels**  
**Molettes de rechange**

---

**ZENTEN**

**Cuchillas de recambio**  
**Ersatzrädchen und Ersatzklingen**  
**Cutting wheels and cutting blades**  
**Molettes de rechange et lames de rechange**

Para mangueras flexibles de plástico.  
 Für flexible Kunststoffschläuche.  
 For flexible plastic hoses.  
 Pour tuyaux flexibles en plastique.

REF.	DISPLAY	
5009-1	●	
+ PTFE		

REF.	DISPLAY	
5011-1	●	
+ PTFE		

Para mangueras flexibles, tubos de plástico de material blando y tubos de plástico de paredes delgadas.  
 Für flexible Schläuche, weiche Kunststoffrohre und dünnwandige Kunststoffrohre.  
 For flexible hoses, soft plastic tubes and thin walled plastic tubes.  
 Pour tuyaux flexibles, tubes en plastique à matériel souple et tubes en plastique à paroi mince.



REF.	DISPLAY	
5007-1	●	
+ PTFE		



Para tubos multicapa.  
 Für Verbundrohre.  
 For multilayer tubes.  
 Pour tubes multicouche.



REF.	DISPLAY	
5008-1	4x ●	
+ PTFE		

REF.	DISPLAY	
5006-1	●	
+ PTFE		

Para tubos de acero e inox.  
 Für Stahl- und Inox Rohre.  
 For steel and inox tubes.  
 Pour tubes en acier et inox.

REF.	 d	 mm	DISPLAY	
6014-0	25x14	5,50	-----	
6014-1	25x14	5,50	●	

REF.	 d	 mm	DISPLAY	
6002-0	31x19	7	-----	
6002-1	31x19	7	●	

REF.	 d	 mm	DISPLAY	
6015-0	41x28	10	-----	
6015-1	41x28	10	●	

## Cuchillas de recambio

### Ersatzrädchen und Ersatzklingen

### Cutting wheels and cutting blades

### Molettes de rechange et lames de rechange

Para tubos metálicos de pared delgada.  
Für dünnwandige Metallrohre.

For thin metal tubes.

Pour tubes métalliques à paroi mince.

#### AL, CU & INOX

REF.  <sup>d</sup> mm DISPLAY

6001-0	19x5	2	----
6001-1	19x5	2	•
6005-0	19x6,2	2	----
6005-1	19x6,2	2	•



REF.  <sup>d</sup> mm DISPLAY

7402-0	25x11	6	----
7402-1	25x11	6	•



#### AL, CU

REF.  <sup>d</sup> mm DISPLAY

6008-0	19x5	2	----
6008-1	19x5	2	•
6009-0	19x6,2	2	----
6009-1	19x6,2	2	•



Para tubos de inox.  
Für Inox Rohre.

For inox tubes.

Pour tubes en inox.

REF.  <sup>d</sup> mm DISPLAY

6001-8	19x5	2,5	----
6001-9	19x5	2,5	•
6005-8	19x6,2	2,5	----
6005-9	19x6,2	2,5	•



Para tubos de plástico y multicapa.

Für Kunststoff- und Verbundrohre.

For plastic and multilayer tubes.

Pour tubes en plastique et multicouche.

REF.  <sup>d</sup> mm DISPLAY

6007-0	22x5	4	----
6007-1	22x5	4	•
6011-0	22x6,2	4	----
6011-1	22x6,2	4	•



REF.  <sup>d</sup> mm DISPLAY

6017-0	30x6,2	8,60	----
6017-1	30x6,2	8,60	•



REF.  <sup>d</sup> mm DISPLAY

7403-0	35x11	11,80	----
7403-1	35x11	11,80	•



+ PTFE

REF.  <sup>d</sup> mm DISPLAY

7404-0	45x11	16,80	----
7404-1	45x11	16,80	•



+ PTFE

REF.  <sup>d</sup> mm DISPLAY

7407-0	45x11	16,80	----
7407-1	45x11	16,80	•



REF.  <sup>d</sup> mm DISPLAY

7405-0	51x11	19,80	----
7405-1	51x11	19,80	•



+ PTFE

REF.  <sup>d</sup> mm DISPLAY

7406-0	67x11	27,80	----
7406-1	67x11	27,80	•



+ PTFE

REF. DISPLAY

5005-1	•
--------	---



+ PTFE

REF. DISPLAY

5003-1	•
--------	---



+ PTFE

REF. DISPLAY

5001-1	•
--------	---



+ PTFE

REF. DISPLAY

5004-1	•
--------	---



+ PTFE

REF. DISPLAY

5002-1	•
--------	---



+ PTFE

# Cuchillas de recambio

## Ersatzrädchen

## Cutting wheels

## Molettes de rechange

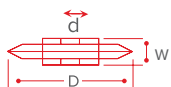

REF.	D mm	d mm	W mm	7016	7316	7025	7325	7030	7330	7035	7335	7036	7336	6230	6430	7230	7530	7135	7435	7235	7535	7145	7445	7245	7545	7476	7576	7477	7478	6042	6050	6054	MATERIAL	MAX. TUBE WALL mm		
6001-0	19.00	5.00	5.00	x	x	x	x	x	x	x	x	x	x	x			x		x														Al, Cu & Inox	2.00		
6001-1	19.00	5.00	5.00	x	x	x	x	x	x	x	x	x	x	x			x		x														Al, Cu & Inox	2.00		
6001-8	19.00	5.00	5.00													x								x									Special For Inox	2.50		
6001-9	19.00	5.00	5.00													x								x									Special For Inox	2.50		
6005-0	19.00	4.85	6.20		x		x		x		x		x		x				x				x			x							Al, Cu & Inox	2.00		
6005-1	19.00	4.85	6.20		x		x		x		x		x		x				x				x			x							Al, Cu & Inox	2.00		
6005-8	19.00	4.85	6.20														x								x								Special For Inox	2.50		
6005-9	19.00	4.85	6.20														x								x								Special For Inox	2.50		
7402-0	25.00	8.00	11.00																										x	x			Al, Cu & Inox	6.00		
7402-1	25.00	8.00	11.00																										x	x			Al, Cu & Inox	6.00		
6017-0	30.00	4.85	6.20																								x						Plastic & Multilayer	8.60		
6017-1	30.00	4.85	6.20																								x						Plastic & Multilayer	8.60		
6007-0	22.00	5.00	5.00															x				x											Plastic & Multilayer	4.00		
6007-1	22.00	5.00	5.00															x				x											Plastic & Multilayer	4.00		
6011-0	22.00	4.85	6.20																x				x										Plastic & Multilayer	4.00		
6011-1	22.00	4.85	6.20																x				x										Plastic & Multilayer	4.00		
7403-0	35.00	8.00	11.00																										x	x				Plastic & Multilayer	11.80	
7403-1	35.00	8.00	11.00																										x	x				Plastic & Multilayer	11.80	
7404-0	45.00	8.00	11.00																										x	x				Plastic & Multilayer	16.80	
7404-1	45.00	8.00	11.00																										x	x				Plastic & Multilayer	16.80	
7405-0	51.00	8.00	11.00																										x	x				Plastic & Multilayer	19.80	
7405-1	51.00	8.00	11.00																										x	x				Plastic & Multilayer	19.80	
7406-0	67.00	8.00	11.00																										x	x				Plastic & Multilayer	27.80	
7406-1	67.00	8.00	11.00																										x	x				Plastic & Multilayer	27.80	
7407-0	45.00	8.00	11.00																										x	x				Soft plastic	16.80	
7407-1	45.00	8.00	11.00																										x	x				Soft plastic	16.80	
6008-0	19.00	5.00	5.00	x		x		x		x		x		x				x				x											Al, Cu	2.00		
6008-1	19.00	5.00	5.00	x		x		x		x		x		x				x				x												Al, Cu	2.00	
6009-0	19.00	4.85	6.20		x		x		x		x		x		x			x				x				x								Al, Cu	2.00	
6009-1	19.00	4.85	6.20		x		x		x		x		x		x			x				x				x								Al, Cu	2.00	
6014-0	25.00	7.60	14.00																											x				Steel & Inox	5.50	
6014-1	25.00	7.60	14.00																											x				Steel & Inox	5.50	
6002-0	31.00	9.05	19.00																													x		Steel & Inox	7.00	
6002-1	31.00	9.05	19.00																													x		Steel & Inox	7.00	
6015-0	41.00	9.70	28.00																														x		Steel & Inox	10.00
6015-1	41.00	9.70	28.00																														x		Steel & Inox	10.00

**Ejes de recambio**  
**Schneidrabefestigungen**  
**Cutting Wheels Axes**  
**Axes de rechange**

REF.	7016	7316	7025	7325	7030	7330	7035	7335	7036	7336	6230 7230	6430 7530	7135 7235	7435 7535	7145 7245	7445 7545	7476 7576	7477	7478	6042	6050	6054	5026 5035 5042 5050 5063
6004-0	x		x		x		x		x		x		x		x								
6004-2		x		x		x		x		x		x		x		x	x						
7401-0																		x	x				
6004-7																					x		
6004-8																						x	
6004-9																							x
5010-0																							x

**ZENTEN**

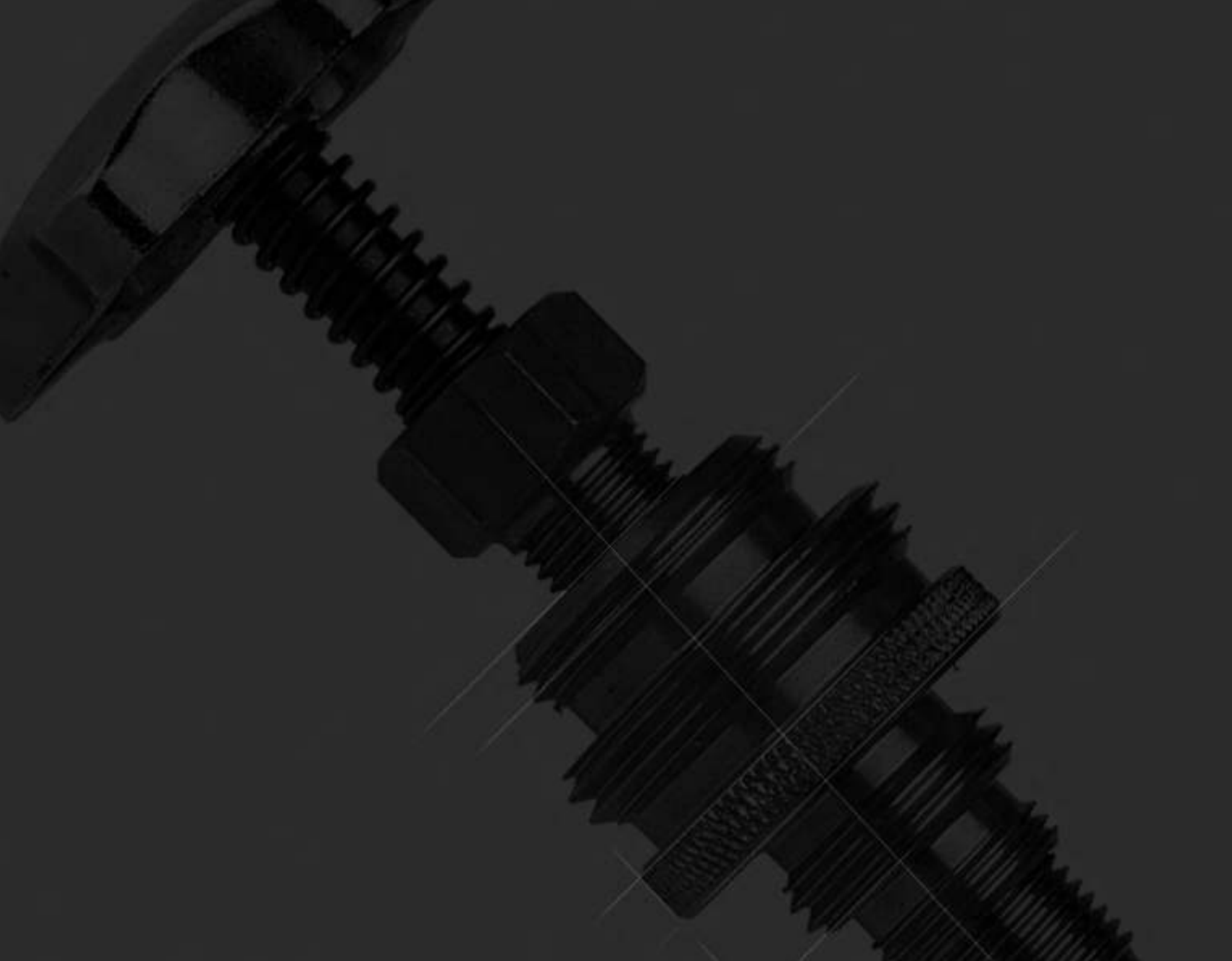

# 09

---

**Herramientas de fontanería**  
**Installationswerkzeuge**  
**Plumbing tools**  
**Outils pour plomberie**

---

ZENTEN

# tools

## Rectificadores de asientos de grifos.

### Wasserhahn-Ventil-Sitzfräser.

### Tap re-seating tools.

### Rectificateur de sièges de robinets.



#### Resistente / Resistent / Resistant / Résistant

- Cuerpo de latón y fresas en acero templado.
- Körper aus Messing und Fräser aus gehärtetem Stahl.
- Brass body and hardened Steel re-seating heads.
- Corps en laiton et fraises en acier trempé.



2 ■ 3/8" + 1/2"

REF.

6111-1 180 • 5 50

2x: juntas · Dichtungen · washers · joints



2 ■ 3/8" + 1/2"

REF.

6112-1 175 • 5 50

2x: juntas · Dichtungen · washers · joints



3 ■ 3/8" + 1/2" + 3/4"  
4 ■ 3/8" + 1/2" + 3/4" + 1"  
5 ■ 1/4" + 3/8" + 1/2" + 3/4" + 1"  
4 ■ 3/8" + 1/2" + 3/4" + 1"

REF.

6105-2 350 1 20/40

6115-2 360 1 20/40

6115-3 365 1 20/40

● 6115-5 925 1 -



4 ■ 3/8" + 1/2" + 3/4" + 1"

REF.

6116-2 530 1 20/40



4 ■ 3/8" + 1/2" + 3/4" + 1"

REF.

6118-2 465 1 20/40

- En caja metálica  
In Metallkassette  
In metallic box  
En coffret métallique



REF: 6260-0

560 1

#### Fresas Lose Fräser Re-seating heads Fraises



REF: 6210-0 / 10mm 1/8"  
REF: 6212-0 / 12mm 1/4"  
REF: 6214-0 / 14mm 3/8"  
REF: 6217-0 / 17mm 1/2"

REF: 6220-0 / 20mm 5/8"  
REF: 6224-0 / 24mm 3/4"  
REF: 6228-0 / 28mm 1"

## Llave de lavabo

### Standhahnmutterschlüssel

### Basin wrench

### Clé à ecrou

MODEL: 6200 SW 32(1.1/4")

REF. mm.

6200-0 240 500 ---- 10 40

6200-1 240 520 • 6 24



#### Resistente / Resistent / Resistant / Résistant

- Cuerpo y garra en acero forjado y mango en acero.
- Stahlgeschmiedeter Körper und Klaue und Knauf aus Drehstahl.
- Frame & Hook: drop forged steel and handle: lathe-steel.
- Corps et griffe en acier forgé et manche en acier.



#### Útil / Handlich / Handy / Utile

- Gancho posicionable a derecha e izquierda.
- Schwenkbare Klaue für Links- und Rechtsgang.
- Hook can be positioned to the right or left.
- Crochet positionnable à droite et à gauche.



CHROM-VANADIUM



# tools

## Rebabador para tubos

### Rohrentgrater

### Pipe reamer

### Ébavureur pour tubes



ø Exterior - Interior (3-42 mm)

REF.	gr.	DISPLAY		
6100-0	40	----	12	72/144
6100-1	55	•	10	40

- Resistente / Resistent / Resistant / Résistant**
- Cuerpo en ABS.
  - Körper aus ABS.
  - ABS body.
  - Corps en ABS.

- Calidad / Qualität / Quality / Qualité**
- Cuchillas de Solingen / Alemania
  - Klingen aus Solingen / Germany.
  - Blades from Solingen / Germany.
  - Lames de Solingen / Allemagne.



ø Exterior - Interior (8-35 mm)

REF.	gr.	DISPLAY		
6101-0	190	----	1	72

- Resistente / Resistent / Resistant / Résistant**
- Cuerpo en Aluminio.
  - Körper aus Aluminium.
  - Aluminium external body.
  - Corps en aluminium

- Calidad / Qualität / Quality / Qualité**
- Pieza rebabador en acero templado.
  - Entgrater aus gehärtetem Stahl.
  - Hardened steel inside reamer.
  - Pièce ébavureur en acier trempé.



ø Exterior - Interior (10-56 mm)

REF.	gr.	DISPLAY		
6102-0	430	----	1	33

- Resistente / Resistent / Resistant / Résistant**
- Cuerpo en Aluminio.
  - Körper aus Aluminium.
  - Aluminium external body.
  - Corps en aluminium

- Calidad / Qualität / Quality / Qualité**
- Pieza rebabador en acero templado.
  - Entgrater aus gehärtetem Stahl.
  - Hardened steel inside reamer.
  - Pièce ébavureur en acier trempé.

## Pinzas de encolar

### Leimzangen

### Spring clips

### Presses à coller



REF.	mm.	gr.	
7100-0	100	45	300/400
7150-0	150	130	100



REF.	mm.	gr.	
7101-0	100	48	300/400
7151-0	150	133	100



# 10

---

**Plomada trazadora**

**Schlagschnurroller**

**Chalk line**

**Cordeau traceur**

---

**ZENTEN**

## MAGNESIUM

**Plomada trazadora**  
**Schlagschnurroller**  
**Chalk line**  
**Cordeau traceur**

REF.				DISPLAY		
8091-0	15m	-	150	----	6	60
8091-1	15m	-	165	●	0	48
8191-1	15m	+60g	245	●	0	48



**8058-0**  
15 m.

REF.				DISPLAY		
8092-0	30m	-	160	----	6	60
8092-1	30m	-	175	●	0	48
8192-1	30m	+60g	255	●	0	48



**8059-0**  
30 m.



Registered Design



### Solución / Lösung / Solution / Solution

- Sistema PUSH: Permite extraer el cordel rápidamente sin que gire la manilla.
- PUSH System: Beim Druck auf die Achse kann die Schnur im Leerlauf ausgezogen werden und die Kurbel dreht nicht.
- PUSH System: Line can be rapidly pulled out with no spin of the handle.
- Système PUSH: Permet au cordeau de sortir rapidement sans que la manivelle tourne.



### Anclaje / Verankerung / Anchorage / Ancre

- Gancho templado con dentado: Ofrece la posibilidad de ser clavado en cantos.
- Gehärteter Haken mit gebogenen Zacken: Kann an Kanten angenagelt werden.
- Hardened hook with bent tips: Can be nailed on edges.
- Crochet trempé avec denté: Offre la possibilité de se clouer sur les arêtes.



### Útil / Handlich / Handy / Utile

- Depósito para el Gancho 100% integrado en el cuerpo.
- Im Körper 100% integrierter Lagerplatz für den Haken.
- Hook storage in the body. The hook is 100% integrated into the tool.
- Cavité dans le corps pour que le crochet reste 100% intégré dans l'outil.



### Eficiente / Effizient / Efficient / Efficient

- Gran capacidad interior para el polvo.
- Große innere Farbpulverkapazität.
- Large inner chalk storage.
- Grand réservoir intérieur pour poudre.



### Calidad / Qualität / Quality / Qualité

- Salida del cordel protegida por anillo de acero.
- Mit Stahl-Öse am Schnuraustritt.
- Line exit protected with steel-ring.
- Sortie du cordeau protégée par anneau en acier.



### Estable / Stabil / Stable / Stable

- Laterales planos para apoyo de la herramienta sobre la superficie a marcar.
- Flache Flanken auf beiden Seiten, damit der Schlagschnurroller waagrecht liegen kann.
- Ergonomic shape with flat sides to lean the tool on the working surface.
- Latéraux plats pour un appui de l'outil sur la surface à marquer.



### Práctico / Praktisch / Practical / Pratique

- Clip colgador en INOX.
- Mit INOX Gürtelclip.
- With INOX belt- hanger clip.
- Avec clip crochet en INOX.

## MAGNESIUM

**Plomada trazadora**  
**Schlagschnurroller**  
**Chalk line**  
**Cordeau traceur**

REF.    DISPLAY  

8096-0	15m	-	210	----	5	50
8096-1	15m	-	225	•	0	36
8196-1	15m	+60g	305	•	0	48



**8058-0**  
15 m.

REF.    DISPLAY  

8097-0	30m	-	220	----	5	50
8097-1	30m	-	235	•	0	36
8197-1	30m	+60g	315	•	0	48



**8059-0**  
30 m.



Registered Design



### Solución / Lösung / Solution / Solution

- Sistema PUSH: Permite extraer el cordel rápidamente sin que gire la manilla.
- PUSH System: Beim Druck auf die Achse kann die Schnur im Leerlauf ausgezogen werden und die Kurbel dreht nicht.
- PUSH System: Line can be rapidly pulled out with no spin of the handle.
- Système PUSH: Permet au cordeau de sortir rapidement sans que la manivelle tourne.



### Anclaje / Verankerung / Anchorage / Ancrage

- Gancho templado con dentado: Ofrece la posibilidad de ser clavado en cantos.
- Gehärteter Haken mit gebogenen Zacken: Kann an kanten angenagelt werden.
- Hardened hook with bent tips: Can be nailed on edges.
- Crochet trempé avec denté: Offre la possibilité de se clouer sur les arêtes.



### Útil / Handlich / Handy / Utile

- Depósito para el Gancho 100% integrado en el cuerpo.
- Im Körper 100% integrierter Lagerplatz für den Haken.
- Hook storage in the body. The hook is 100% integrated into the tool.
- Cavité dans le corps pour que le crochet reste 100% intégré dans l'outil.



### Eficiente / Effizient / Efficient / Efficient

- Gran capacidad interior para el polvo.
- Große innere Farbpulverkapazität.
- Large inner chalk storage.
- Grand réservoir intérieur pour poudre.



### Calidad / Qualität / Quality / Qualité

- Salida del cordel protegida por anillo de acero.
- Mit Stahl-Öse am Schnuraustritt.
- Line exit protected with steel-ring.
- Sortie du cordeau protégée par anneau en acier.



### Práctico / Praktisch / Practical / Pratique





- Clip colgador en INOX.
- Mit INOX Gürtelclip.
- With INOX belt- hanger clip.
- Avec clip crochet en INOX.



### Rápido / Schnell / Quick / Rapide





- Velocidad de recogida 5:1
- Schnelleinzug Übersetzung 5:1
- Rewind speed 5:1
- Vitesse de reboinage 5:1

**Plomada trazadora PP**  
**Schlagschnurroller PP**  
**Chalk line PP**  
**Cordeau traceur PP**

REF.				DISPLAY		
8053-0	15m	-	80	-----	5	50
8053-1	15m	-	100	●	0	54
8153-1	15m	+60g	180	●	0	36



**8058-0**  
15 m.

REF.				DISPLAY		
8054-0	30m	-	90	-----	5	50
8054-1	30m	-	110	●	0	54
8154-1	30m	+60g	190	●	0	36



**8059-0**  
30 m.



**Eficiente / Effizient / Efficient / Efficient**

- Gran capacidad interior para el polvo.
- Große innere Farbpulverkapazität.
- Large inner chalk storage.
- Grand réservoir intérieur pour poudre.



**Calidad / Qualität / Quality / Qualité**

- Salida del cordel protegida por anillo de acero.
- Mit Stahl-Öse am Schnuraustritt.
- Line exit protected with steel-ring.
- Sortie du cordeau protégée par anneau en acier.









**Anclaje / Verankerung / Anchorage / Anclage**







- Gancho templado con dentado: ofrece la posibilidad de ser clavado en cantos.
- Gehärteter Haken mit gebogenen Zacken: kann an Kanten angenagelt werden.
- Hardened hook with bent tips: can be nailed on edges.
- Crochet trempé avec denté: offre la possibilité de se clouer sur les arêtes.

**Polvo para plomada trazadora**  
**Farbpulver für Schlagschnurroller**  
**Chalk for chalk line**  
**Poudre pour cordeau traceur**

**Frascos a granel**  
**Flaschen, Lose**  
**Flasks, Bulk**  
**Flacons, en Vrac**

							
100g.	8064-0	8064-2	8064-4	8064-6	-	-	100
250g.	8066-0	8066-2	8066-4	8066-6	-	-	50
500g.	8068-0	8068-2	-	-	-	-	35
1000g.	8070-0	8070-2	-	-	-	-	24

**Frascos con colgador**  
**Flaschen mit Aufhänger**  
**Flasks with hanger**  
**Flacons avec accrochoir**

							
100g.	8064-1	8064-3	8064-5	8064-7	6	6	72
250g.	8066-1	8066-3	8066-5	8066-7	6	6	60







11

---

**Cuchillos**  
**Messer**  
**Knives**  
**Couteaux**

---







ZENTEN

## Cuchillo universal

### Universalmesser

### Fixed trimming knife

### Couteau à lame fixe

	REF.			DISPLAY		
	8971-2	1x	240	----	10	100
	8971-3	1x	265	•	6	72
	8981-2	1x	280	----	10	50
	8981-3	1x	305	•	0	25

  
**8002-0**  
 (60x19x0,65)

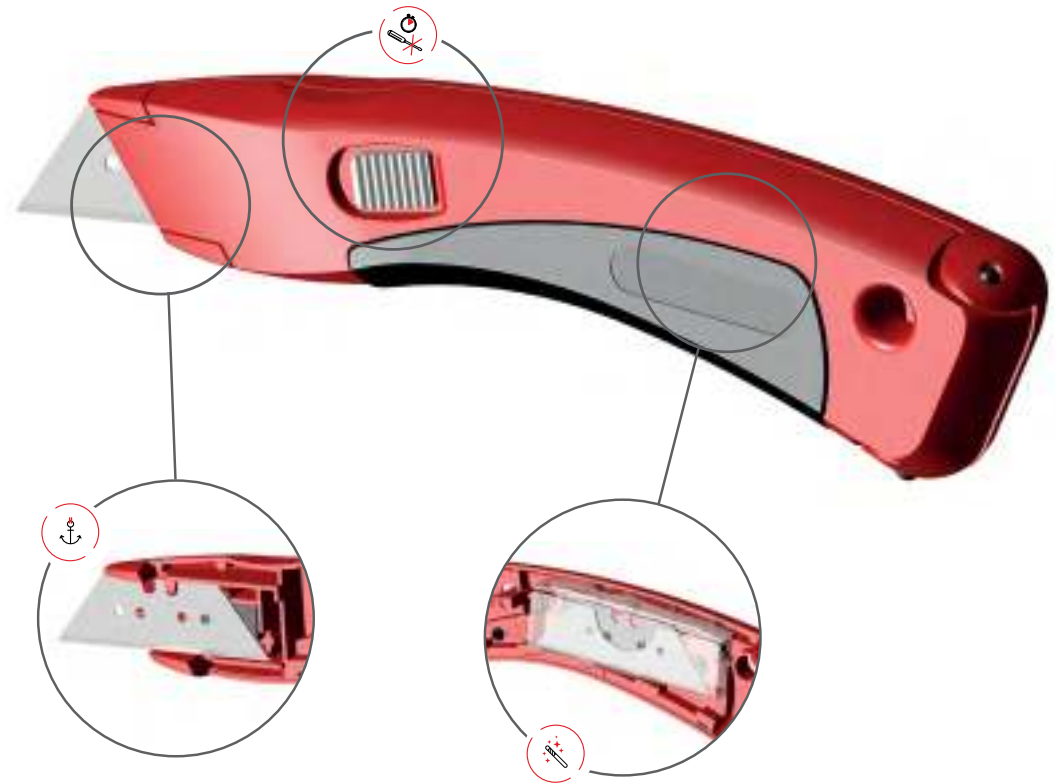

Registered Design



#### Instantáneo / Sofortiger / Instant / Instantané

- Cambio rápido de cuchilla sin herramienta.
- Klängen-Schnellwechsel ohne Werkzeug.
- No tool required for fast blade change.
- Changement rapide de la lame sans besoin d'outil.



#### Útil / Handlich / Handy / Utile

- Depósito para las cuchillas.
- Klingendepot.
- Internal blade deposit.
- Réservoir pour lames.



#### Anclaje / Verankerung / Anchorage / Ancre

- Sujeción de la cuchilla mediante imán.
- Klingenthalterung mit Magnet.
- Blade fastening by means of a magnet.
- Assujettissement de la lame par aimant.



#### Confort / Komfort / Comfort / Confort







- Diseño ergonómico con empuñaduras de goma.
- Ergonomisches Design mit Kautschuckeinlagen.
- Ergonomic design with rubber grips.
- Ligne ergonomique avec manches en caoutchouc.

## Cuchillo retráctil

### Sicherheitsmesser

### Retractable trimming knife

### Couteau de sécurité

	REF.			DISPLAY		
	8952-2	2x	295	----	8	80
	8952-3	2x	320	•	5	50
	8962-2	2x	335	----	5	50
	8962-3	2x	360	•	0	25

 **8002-0**  
(60x19x0,65)



Registered Design



#### Instantáneo / Sofortiger / Instant / Instantané

- Cambio rápido de cuchilla sin herramienta.
- Klingen-Schnellwechsel ohne Werkzeug.
- No tool required for fast blade change.
- Changement rapide de la lame sans besoin d'outil.



#### Útil / Handlich / Handy / Utile

- Depósito para las cuchillas.
- Klingendepot.
- Internal blade deposit.
- Réservoir pour lames.



#### Eficiente / Effizient / Efficient / Efficient

- Sistema de muelles y bolas de acero para minimizar la holgura de la cuchilla.
- Kugel-Federsystem zur Fixierung der Klinge.
- Balls with spring system on the edge of the knife in order to minimize the looseness of the blade.
- Système à ressort et boules en acier pour réduire l'ampleur de la lame.



#### Anclaje / Verankerung / Anchorage / Ancre

- Sujeción de la cuchilla mediante imán.
- Klingenthalterung mit Magnet.
- Blade fastening by means of a magnet.
- Assujettissement de la lame par aimant.



#### Confort / Komfort / Comfort / Confort









- Diseño ergonómico con empuñaduras de goma.
- Ergonomisches Design mit Kautschuckeinlagen.
- Ergonomic design with rubber grips.
- Ligne ergonomique avec manches en caoutchouc.

## Cuchillo de hoja partible

### Abbrechklingen-Messer

### Snap-off blade knife

### Couteau à lame cassable

REF.			DISPLAY		
8703-0	3	30	----	100	400
8703-1	3	45	•	30	120
REF.			DISPLAY		
8703-2	3	60	----	60	240
8703-3	3	70	•	30	120

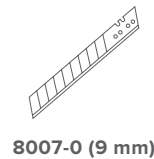
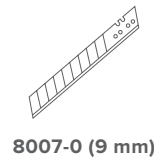

Registered Design



#### Útil / Handlich / Handy / Utile

- Con 2 hojas de reserva en el depósito interior.
- Mit 2 Ersatzklingen im Klingendepot.
- 2 spare blades in the internal blade deposit.
- Avec 2 lames de rechange dans le réservoir.



#### Seguridad / Sicherheit / Safety / Sécurité

- Bloqueo de la cuchilla mediante freno pulsador.
- Blockiersystem des Schiebers.
- Blade blocking by means of break button.
- Blocage de la lame par frein-poussoir.



#### Práctico / Praktisch / Practical / Pratique

- Partidor de hoja incorporado en la parte trasera.
- Mit Klingenabbrecher.
- Blade divider incorporated on the back of the knife.
- Partiteur de lame incorporé dans la partie arrière.



#### Protección / Schutz / Protection / Protection





- Con capuchón de seguridad.
- Mit Schutzkappe.
- With security cap.
- Avec capuchon de sécurité.

## Cuchillo de hoja partible





### Abbrechklingen-Messer

### Snap-off blade knife

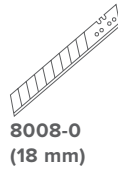
### Couteau à lame cassable

REF.			DISPLAY		
8713-0	3	220	----	12	120
8713-1	3	230	•	6	60



REF.			DISPLAY		
8723-0	3	245	----	12	120
8723-1	3	255	•	6	60

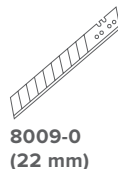

Registered Design



#### Útil / Handlich / Handy / Utile

- Con 2 hojas de reserva en el depósito interior.
- Mit 2 Ersatzklingen im Klingendepot.
- 2 spare blades in the internal blade deposit.
- Avec 2 lames de rechange dans le réservoir.



#### Solución / Lösung / Solution / Solution

- Carga automática de las hojas.
- Automatische Klingennachladung.
- Automatic blade loading.
- Charge automatique des lames.



#### Seguridad / Sicherheit / Safety / Sécurité





- Bloqueo de la cuchilla mediante freno pulsador.
- Blockiersystem des Schiebers.
- Blade blocking by means of break button.
- Blocage de la lame par frein-poussoir.



#### Confort / Komfort / Comfort / Confort

- Diseño ergonómico con empuñadura de goma.
- Ergonomisches Design mit Kautschuckeinlage.
- Ergonomic design with rubber grip.
- Ligne ergonomique avec manche en caoutchouc.

**Cuchillo universal**  
**Universalmesser**  
**Fixed trimming knife**  
**Couteau à lame fixe**

REF.			DISPLAY		
8731-2	1	180	----	24	96
8731-3	1	195	•	10	120

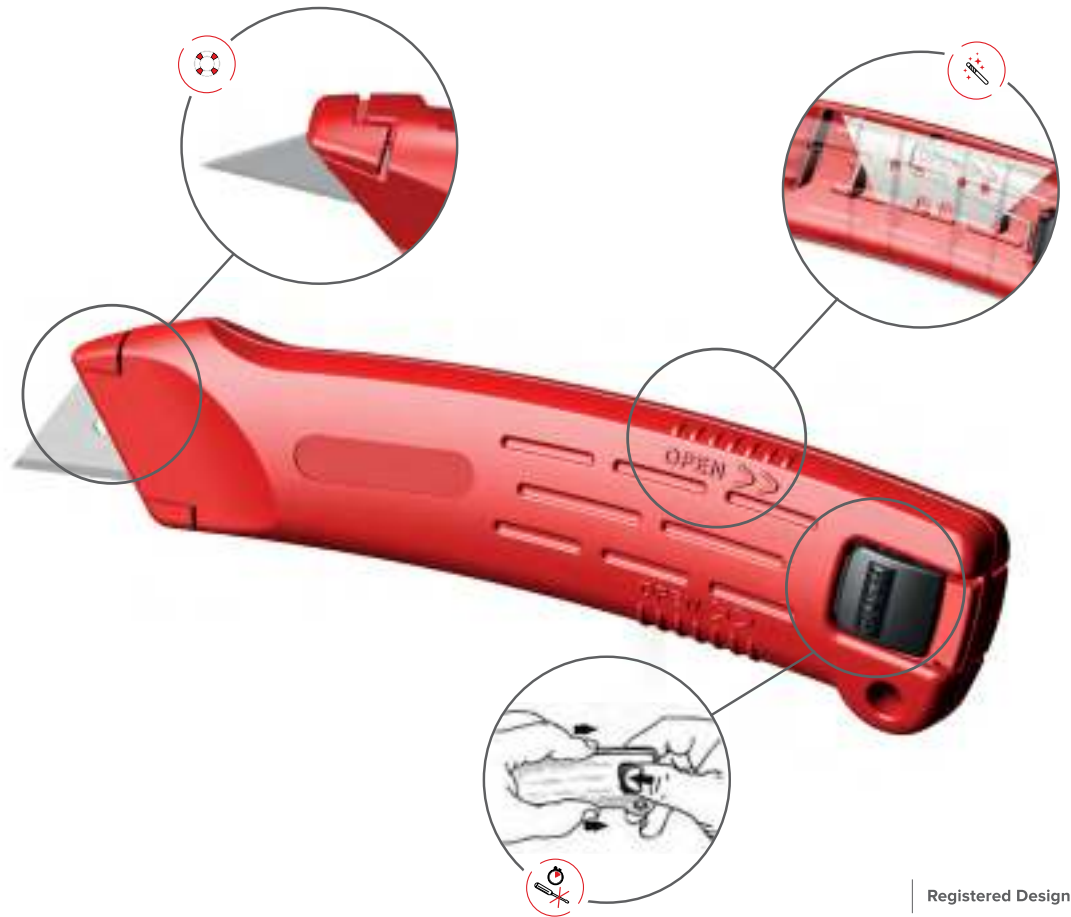

Registered Design



**Instantáneo / Sofortiger / Instant / Instantané**

- Cambio rápido de cuchilla sin herramienta.
- Klängen-Schnellwechsel ohne Werkzeug.
- No tool required for fast blade change.
- Changement rapide de la lame sans besoin d'outil.



**Útil / Handlich / Handy / Utile**

- Depósito para cuchillas.
- Klingendepot.
- Internal blade deposit.
- Réservoir pour lames.



**Protección / Schutz / Protection / Protection**





- Sistema interlock.
- Interlock System.
- Interlock system.
- Système interlock.



**Confort / Komfort / Comfort / Confort**

- Diseño ergonómico.
- Ergonomisches Design.
- Ergonomic design.
- Ligne ergonomique.

**Cuchillo retráctil**  
**Sicherheitsmesser**  
**Retractable trimming knife**  
**Couteau de sécurité**

REF.			DISPLAY		
8741-2	1	185	----	24	96
8741-3	1	200	•	10	120

 **8002-0**  
**(60x19x0,65)**

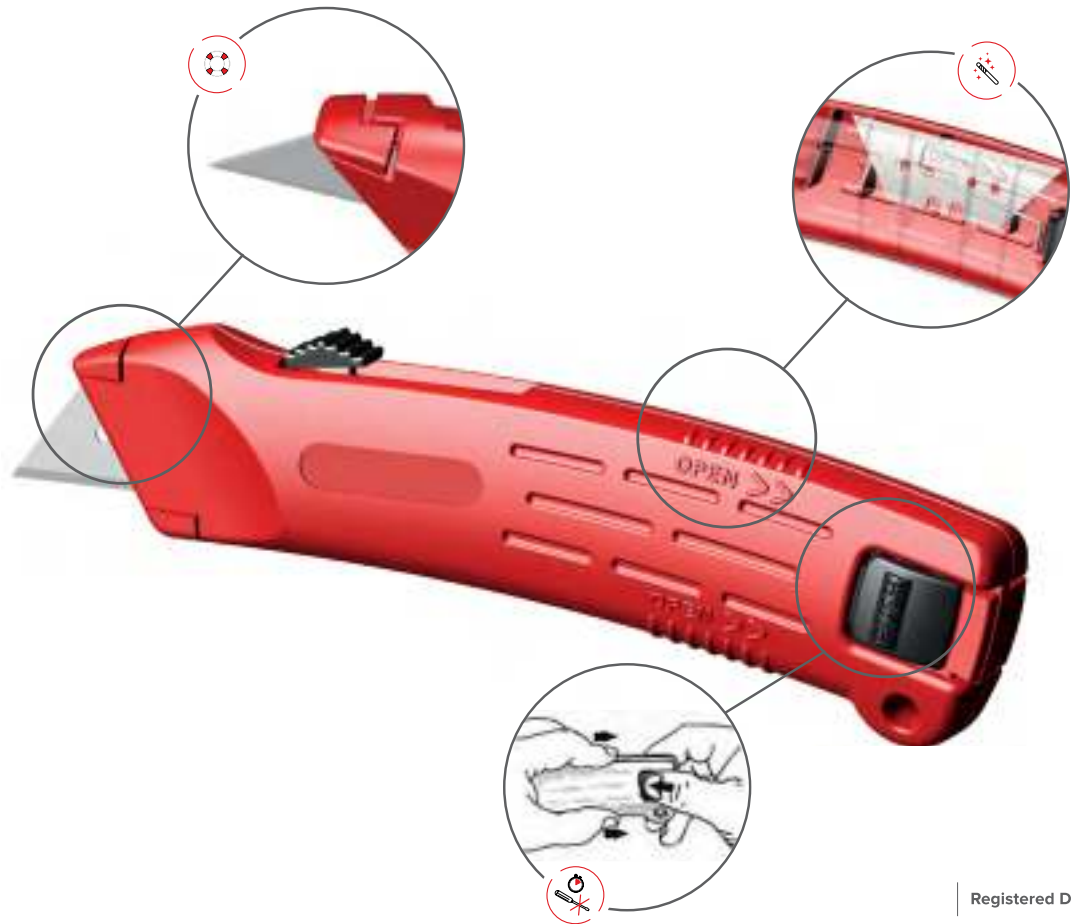

Registered Design

-  **Instantáneo / Sofortiger / Instant / Instantané**
- Cambio rápido de cuchilla sin herramienta.
  - Klingen-Schnellwechsel ohne Werkzeug.
  - No tool required for fast blade change.
  - Changement rapide de la lame sans besoin d'outil.





-  **Protección / Schutz / Protection / Protection**
- Sistema interlock.
  - Interlock System.
  - Interlock system.
  - Système interlock.

-  **Práctico / Praktisch / Practical / Pratique**
- Suave avance del carro.
  - Leichter Vorschub des Schiebers.
  - Soft advance of the slider.
  - Avance douce du poussoir.

-  **Útil / Handlich / Handy / Utile**
- Depósito para cuchillas.
  - Klingendepot.
  - Internal blade deposit.
  - Réservoir pour lames.

-  **Confort / Komfort / Comfort / Confort**
- Diseño ergonómico.
  - Ergonomisches Design.
  - Ergonomic design.
  - Ligne ergonomique.

**Cuchillo automático**  
**Automatikmesser**  
**Automatic knife**  
**Couteau automatique**

REF.			DISPLAY		
8751-2	1	185	----	24	96
8751-3	1	200	•	10	120

 **8002-0**  
**(60x19x0,65)**

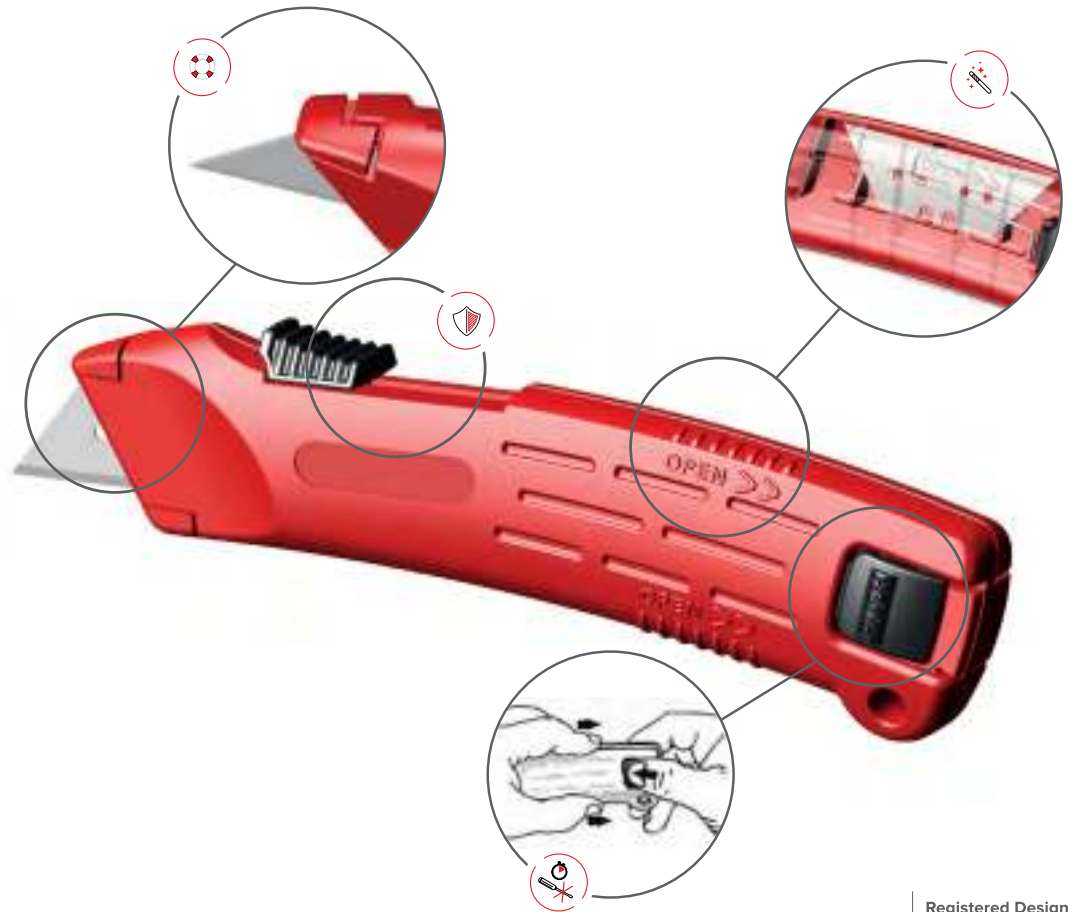



Registered Design

-  **Instantáneo / Sofortiger / Instant / Instantané**
- Cambio rápido de cuchilla sin herramienta.
  - Klängen-Schnellwechsel ohne Werkzeug.
  - No tool required for fast blade change.
  - Changement rapide de la lame sans besoin d'outil.

-  **Seguridad / Sicherheit / Safety / Sécurité**
- Retroceso automático de la cuchilla.
  - Mit automatischem Rückzug der Klinge.
  - Automatic return of the blade.
  - Retour automatique de la lame.

-  **Confort / Komfort / Comfort / Confort**
- Diseño ergonómico.
  - Ergonomisches Design.
  - Ergonomic design.
  - Ligne ergonomique.

-  **Protección / Schutz / Protection / Protection**
- Sistema interlock.
  - Interlock System.
  - Interlock system.
  - Système interlock.

-  **Útil / Handlich / Handy / Utile**
- Depósito para cuchillas.
  - Klingendepot.
  - Internal blade deposit.
  - Réservoir pour lames.



**Cuchillo para material aislante**  
**Dämmstoffmesser**  
**Insulating material cutting knife**  
**Couteau pour materiel isolant**

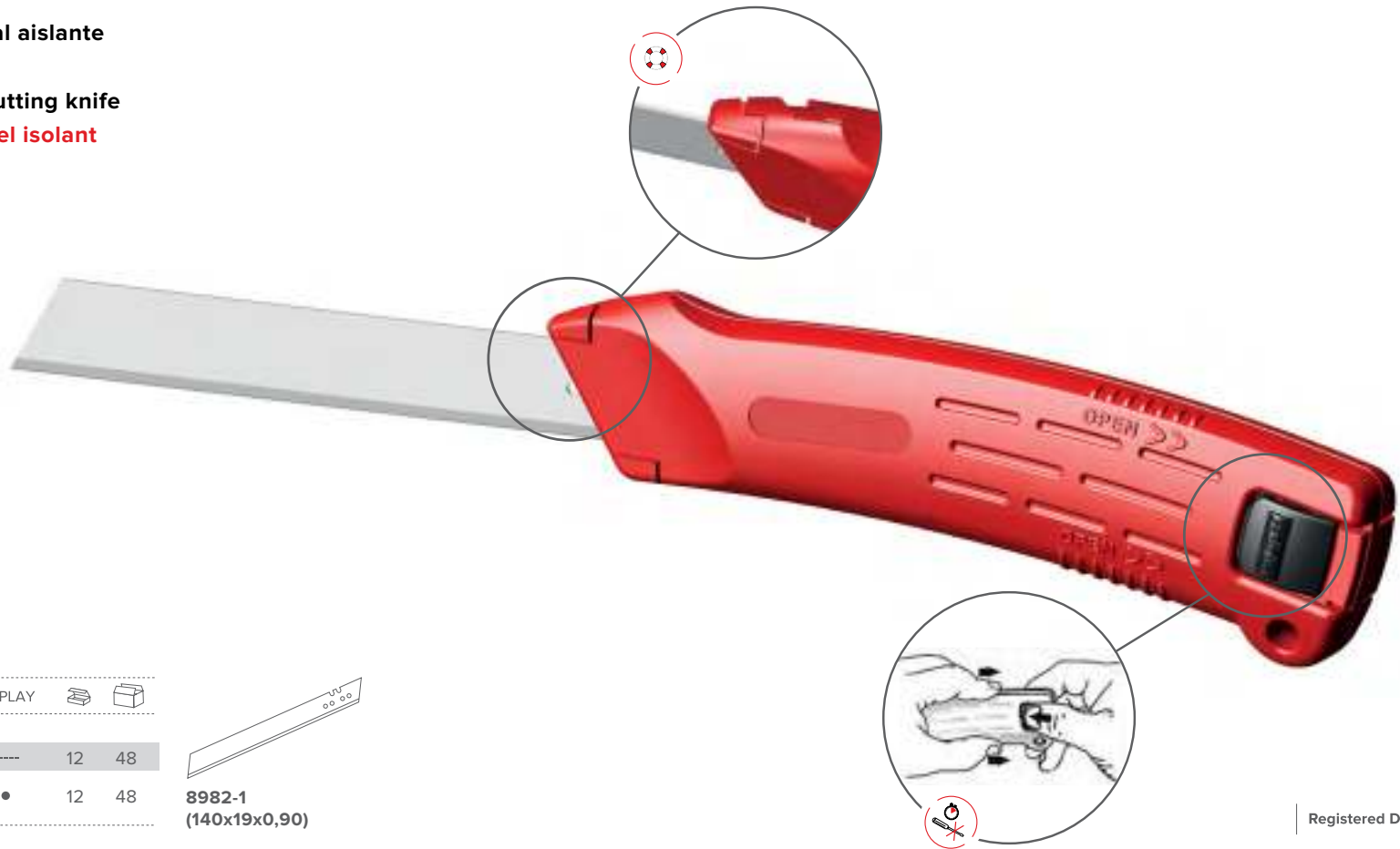

REF.			DISPLAY		
8780-0	1	205	----	12	48
8780-1	1	235	•	12	48

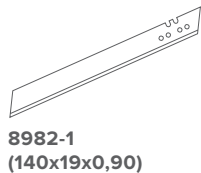

Registered Design



**Instantáneo / Sofortiger / Instant / Instantané**

- Cambio rápido de cuchilla sin herramienta.
- Klängen-Schnellwechsel ohne Werkzeug.
- No tool required for fast blade change.
- Changement rapide de la lame sans besoin d'outil.



**Confort / Komfort / Comfort / Confort**

- Diseño ergonómico.
- Ergonomisches Design.
- Ergonomic design.
- Ligne ergonomique.



**Protección / Schutz / Protection / Protection**

- Sistema interlock.
- Interlock System.
- Interlock system.
- Système interlock.

**Cuchillo universal**  
**Universalmesser**  
**Fixed trimming knife**  
**Couteau à lame fixe**

8002-0 (60x19x0,65) REF.   DISPLAY  



8031-2	1	125	----	30	120
8031-3	1	140	●	10	100



**Confort / Komfort / Comfort / Confort**

- Diseño ergonómico.
- Ergonomisches Design.
- Ergonomic design.
- Ligne ergonomique.

MODEL: 8031



8002-0 (60x19x0,65) REF.   DISPLAY  



8121-2	1	140	----	30	120
--------	---	-----	------	----	-----



**Confort / Komfort / Comfort / Confort**

- Diseño ergonómico.
- Ergonomisches Design.
- Ergonomic design.
- Ligne ergonomique.

MODEL: 8121



**Para material aislante**  
**Für Dämmstoff**  
**For insulating material**  
**Pour matériel isolant.**

8982-1 (140x19x0,90) REF.   DISPLAY  



8980-0	1	205	----	12	48
8980-1	1	235	●	12	48



**Confort / Komfort / Comfort / Confort**

- Diseño ergonómico.
- Ergonomisches Design.
- Ergonomic design.
- Ligne ergonomique.

MODEL: 8980-0/1



**Cuchillo de seguridad**  
**Sicherheitsmesser**  
**Retractable trimming knife**  
**Couteau de sécurité**

8002-0 (60x19x0,65) REF.   DISPLAY  



8041-2	1	155	----	30	120
8041-3	1	170	●	10	100



**Confort / Komfort / Comfort / Confort**

- Diseño ergonómico.
- Ergonomisches Design.
- Ergonomic design.
- Ligne ergonomique.

MODEL: 8041-2/3



**Práctico / Praktisch / Practical / Pratique**

- Suave avance del carro gracias al sistema de muelle.
- Leichter Vorschub des Schiebers dank Federsystem.
- Soft advance of the slider, thanks to the spring system.
- Douce avance du poussoir grace au système du ressort.

**Cuchillo automático**  
**Automatikmesser**  
**Automatic knife**  
**Couteau automatique**

8002-0 (60x19x0,65) REF.   DISPLAY  



8141-2	1	170	----	30	120
8141-3	1	185	●	10	120



**Confort / Komfort / Comfort / Confort**

- Diseño ergonómico.
- Ergonomisches Design.
- Ergonomic design.
- Ligne ergonomique.

MODEL: 8141



**Protección / Schutz / Protection / Protection**

- Retroceso automático de la cuchilla.
- Mit automatischem Rückzug der Klinge.
- Automatic return of the blade.
- Retour automatique de la lame



**Hojas de recambio para cuchillos**  
**Ersatzklingen für Messer**  
**Spare blades for knives**  
**Lames de rechange pour couteaux**

	REF.	Pcs.		8731	8031	8121	8741	8041	8751	8141	8971	8981	8952	8962	8780	8980	8703	8713	8723
60x19x0,65	8002-0	5	100	x	x	x	x	x	x	x	x	x	x	x					
	8012-0	10	100	x	x	x	x	x	x	x	x	x	x	x					
	8012-1	10	50	x	x	x	x	x	x	x	x	x	x	x					
52x19x0,5	8005-0	5	100	x	x	x	x	x	x	x	x	x	x	x					
	8015-0	10	100	x	x	x	x	x	x	x	x	x	x	x					
	8015-1	10	50	x	x	x	x	x	x	x	x	x	x	x					
140x19x0,9	8982-1	2	50			x									x	x			
9 mm 18 mm 22 mm	8007-0	10	100															x	
	8008-0	10	100																x
	8009-0	10	100																x



60x19x0,65



52x19x0,5



9 mm  
18 mm  
22 mm

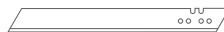

140x19x0,9





# ZENTEN

## PHONE

National: 943 612 102

International: +34 943 613 012

## FAX

National: 943 612 041

International: +34 943 612 041

## Zenten Bernhard Groten S.L.

Polígono Industrial Soroxarta, Burniola Kalea, 20C  
Apartado 456 (POB) - E-20305 Irun (SPAIN)

[www.zentenbg.com](http://www.zentenbg.com)

[webmaster@zentenbg.com](mailto:webmaster@zentenbg.com)



**ALBERTO  
GROTEN**

MANAGING DIRECTOR

[alberto@zentenbg.com](mailto:alberto@zentenbg.com)

**REGINA  
VALENCIAGA**

AREA EXPORT MANAGER

[regina@zentenbg.com](mailto:regina@zentenbg.com)

**ZIGOR  
VAZQUEZ**

SALES MANAGER

[zvazquez@zentenbg.com](mailto:zvazquez@zentenbg.com)



ZENTEN

[www.zentenbg.com](http://www.zentenbg.com)